

User's Guide

Precision Current Source LDX-3200 Series

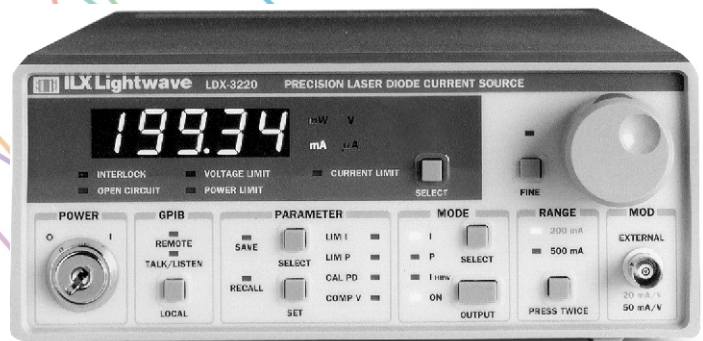

 **ILX Lightwave**
Photonic Test & Measurement Instrumentation

ILX Lightwave Corporation · P. O. Box 6310 · Bozeman, MT, U.S.A. 59771 · U.S. & Canada: 1-800-459-9459 · International Inquiries: 406-586-1244 · Fax 406-586-9405
E-mail: support@ilxlightwave.com

www.ilxlightwave.com

SAFETY AND WARRANTY INFORMATION



The Safety and Warranty Information section provides details about cautionary symbols used in the manual, safety markings used on the instrument, and information about the Warranty including Customer Service contact information.

Safety Information and the Manual

Throughout this manual, you will see the words *Caution* and *Warning* indicating potentially dangerous or hazardous situations which, if not avoided, could result in death, serious or minor injury, or damage to the product. Specifically:

CAUTION

Caution indicates a potentially hazardous situation which can result in minor or moderate injury or damage to the product or equipment.

WARNING

Warning indicates a potentially dangerous situation which can result in serious injury or death.

WARNING

Visible and/or invisible laser radiation. Avoid direct exposure to the beam.

General Safety Considerations

If any of the following conditions exist, or are even suspected, do not use the instrument until safe operation can be verified by trained service personnel:

- Visible damage
- Severe transport stress
- Prolonged storage under adverse conditions
- Failure to perform intended measurements or functions

If necessary, return the instrument to ILX Lightwave, or authorized local ILX Lightwave distributor, for service or repair to ensure that safety features are maintained (see the contact information on page vi).

All instruments returned to ILX Lightwave are required to have a Return Authorization Number assigned by an official representative of ILX Lightwave Corporation. See Returning an Instrument on page v for more information.

SAFETY SYMBOLS









This section describes the safety symbols and classifications.

Technical specifications including electrical ratings and weight are included within the manual. See the Table of Contents to locate the specifications and other product information. The following classifications are standard across all ILX Lightwave products:

- Indoor use only
- Ordinary Protection: This product is NOT protected against the harmful ingress of moisture.
- Class I Equipment (grounded type)
- Mains supply voltage fluctuations are not to exceed $\pm 10\%$ of the nominal supply voltage.
- Pollution Degree II
- Installation (overvoltage) Category II for transient overvoltages
- Maximum Relative Humidity: $< 80\%$ RH, non-condensing
- Operating temperature range of $0\text{ }^{\circ}\text{C}$ to $40\text{ }^{\circ}\text{C}$
- Storage and transportation temperature of $-40\text{ }^{\circ}\text{C}$ to $70\text{ }^{\circ}\text{C}$
- Maximum altitude: 3000 m (9843 ft)
- This equipment is suitable for continuous operation.

Safety Marking Symbols

This section provides a description of the safety marking symbols that appear on the instrument. These symbols provide information about potentially dangerous situations which can result in death, injury, or damage to the instrument and other components.

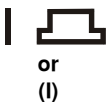
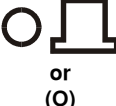
 <p>Caution, refer to manual</p>	 <p>Earth ground Terminal</p>	 <p>Alternating current</p>	 <p>Visible and/or invisible laser radiation</p>
 <p>Caution, risk of electric shock</p>	 <p>Protective Conductor Terminal</p>	 <p>Caution, hot surface</p>	 <p>Frame or chassis Terminal</p>
 <p>On: In position of a bistable push control. The slash (I) only denotes that mains are on.</p>		 <p>Off: Out position of a bistable push control. The circle (O) only denotes that mains are off.</p>	

WARRANTY

ILX LIGHTWAVE CORPORATION warrants this instrument to be free from defects in material and workmanship for a period of one year from date of shipment. During the warranty period, ILX will repair or replace the unit, at our option, without charge.

Limitations

This warranty does not apply to fuses, lamps, defects caused by abuse, modifications, or to use of the product for which it was not intended.

This warranty is in lieu of all other warranties, expressed or implied, including any implied warranty of merchantability or fitness for any particular purpose. ILX Lightwave Corporation shall not be liable for any incidental, special, or consequential damages.

If a problem occurs, please contact ILX Lightwave Corporation with the instrument's serial number, and thoroughly describe the nature of the problem.

Returning an Instrument

If an instrument is to be shipped to ILX Lightwave for repair or service, be sure to:

- 1 Obtain a Return Authorization number (RA) from ILX Customer Service.
- 2 Attach a tag to the instrument identifying the owner and indicating the required service or repair. Include the instrument serial number from the rear panel of the instrument.
- 3 Attach the anti-static protective caps that were shipped with the instrument and place the instrument in a protective anti-static bag.
- 4 Place the instrument in the original packing container with at least 3 inches (7.5 cm) of compressible packaging material. **Shipping damage is not covered by this warranty.**
- 5 Secure the packing box with fiber reinforced strapping tape or metal bands.
- 6 Send the instrument, transportation pre-paid, to ILX Lightwave. Clearly write the return authorization number on the outside of the box and on the shipping paperwork. ILX Lightwave recommends you insure the shipment.

If the original shipping container is not available, place your instrument in a container with at least 3 inches (7.5 cm) of compressible packaging material on all sides.

Repairs are made and the instrument returned transportation pre-paid. Repairs are warranted for the remainder of the original warranty or for 90 days, whichever is greater.

Claims for Shipping Damage

When you receive the instrument, inspect it immediately for any damage or shortages on the packing list. If the instrument is damaged, file a claim with the carrier. The factory will supply you with a quotation for estimated costs of repair. You must negotiate and settle with the carrier for the amount of damage.

Comments, Suggestions, and Problems

To ensure that you get the most out of your ILX Lightwave product, we ask that you direct any product operation or service related questions or comments to ILX Lightwave Customer Support. You may contact us in whatever way is most convenient:

Phone (800) 459-9459 or (406) 586-1244

Fax (406) 586-9405

Email support@ilxlightwave.com

Or mail to:

ILX Lightwave Corporation
P. O. Box 6310
Bozeman, Montana, U.S.A 59771
www.ilxlightwave.com

When you contact us, please have the following information:

Model Number: _____

Serial Number: _____

End-user Name: _____

Company: _____

Phone: _____

Fax: _____

Description or sketch of what
is connected to the ILX
Lightwave instrument:

Description of the problem:

If ILX Lightwave determines that a return to the factory is necessary, you are issued a Return Authorization (RA) number. Please mark this number on the outside of the shipping box.

You or your shipping service are responsible for any shipping damage when returning the instrument to ILX Lightwave; ILX recommends you insure the shipment. If the original shipping container is not available, place your instrument in a container with at least 3 inches (7.5cm) of compressible packaging material on all sides.

We look forward to serving you even better in the future!

Table of Contents

Chapter 1 Introduction to the LDX-3200 Series

Introduction	1
Safety Symbols and Terms	2
Product Overview	2
Initial Inspection	2
Installing your LDX-3200 Precision Current Source.....	3
Maintenance	4
How to Obtain Repair Services	6
LDX-3200 Series Specifications.....	6
Available Options and Accessories	8

Chapter 2 How to Operate Your LDX-3200

Introduction	1
Applying Power to Your LDX-3200	1
Connecting to the Laser	2
Front Panel Operation	5
Operating a Laser in Constant Current, “I” Mode	5
Operating a Laser in Constant Power Mode, P.....	7
Error Indicators	8

Chapter 3 Operating in Remote Control

Introduction	1
LDC-3700B Series Current Source Command Set.....	2
Status Reporting.....	7

Chapter 4 Command Reference

Introduction	1
LDX-3200 Series Device-Dependent Commands	4
LDX-3200 Series Device-Dependent Command Reference	5

Chapter 5 Functions and Features

Introduction	1
Saving and Recalling from the Front Panel.....	1
Using the Laser Compliance Voltage Adjustment	2
Using the LDX-3200 Trigger Function.....	2
Modulating the Laser Current Source.....	3

Chapter 6 Calibration and Troubleshooting Guide

Introduction	1
Local Calibration of the LDX-3200 Series Current Source.....	2
Remote Calibration of the LDX-3200 Series Current Source	6
Troubleshooting Guide	10

CHAPTER 1	1
INTRODUCTION TO THE LDX-3200 SERIES	1
Introduction	1
Product Overview	2
Initial Inspection	2
Installing Your LDX-3200 Precision Current Source	3
Grounding requirements	3
AC Line Power Requirements	3
GPIB Connector	3
The GPIB Address	3
Tilt-Foot Adjustment	4
Operating the LDX-3200 Precision Current Source	4
Maintenance	5
How to Obtain Repair Services	6
General Shipping Instructions	6
LDX-3200 Series Specifications	7
Laser Current Source Specifications	7
Available Options and Accessories	8

CHAPTER 1

INTRODUCTION TO THE LDX-3200 SERIES

INTRODUCTION

This chapter is an introduction to the LDX-3200 Series Precision Current Sources containing unpacking information, instructions on how to install and apply power, and safety considerations and instructions. It also contains some maintenance information, specifications, and listings of the LDX-3200 options and accessories.

WARNING

If any of the following symptoms exist, or are even suspected, remove the LDX-3200 from service. Do not use the LDX-3200 until trained service personnel can verify safe operation.

1. *Visible damage*
2. *Severe transport stress*
3. *Prolonged storage under adverse conditions*
4. *Failure to perform intended measurements or functions*

If necessary, return the LDX-3200 to ILX Lightwave for service and repair to ensure that safety features are maintained.

In order to get the most out of your ILX Lightwave product, we ask that you direct any product operation or service related questions or comments to **Customer Support** at 1-800-459-9459 (USA and Canada), 406-586-1244 (International) or by fax at 406-586-9405. Or E-mail us at SUPPORT@ILXLIGHTWAVE.COM.

When calling, please have the following information on hand (if applicable):

- 1) Product Model: _____
- 2) Unit Serial Number: _____
- 3) End user name and telephone/fax
Name: _____
Company: _____
Phone: _____
Fax: _____
- 4) Description/sketch of what is connected to the ILX Lightwave instrument.
- 5) Description of the problem.

SAFETY SYMBOLS AND TERMS

The following safety terms are used in this manual:

- The **WARNING** heading explains dangers that could result in personal injury or death.
- The **CAUTION** heading explains hazards that could damage your instrument.
- The **NOTES** heading gives information to the user that may be beneficial in the use of the instrument and to the devices being tested.

The following symbols are used in this manual and on the instrument:



Earth Ground and/or Protective conductor terminal



Caution: Refer to accompanying documents



Caution: Risk of Electrical Shock



Instrument Power Off



Instrument Power On

PRODUCT OVERVIEW

The LDX-3200 Series instruments are precision current sources. They provide a high stability output with a fully redundant current limit and multiple laser protection features. The LDX-3200 Series' fast, sophisticated GPIB option lets you automate your experiment.

INITIAL INSPECTION

When you receive your LDX-3200 instrument, verify that the following items were shipped with the instrument:

LDX-3200 Series Precision Current Source

LDX-3200 Series Instruction Manual

Power Cord

Shipping Kit

INSTALLING YOUR LDX-3200 PRECISION CURRENT SOURCE

Grounding requirements

The LDX-3200 Series Precision Current Source comes with a three conductor AC power cable. The power cable must either be plugged into an approved three-contact electrical outlet or used with a three-contact or two-contact adapter with the grounding wire connected to an electrical ground (safety ground). The LDX-3200's power jack and supplied power cable meet IEC safety standards.

AC Line Power Requirements

You can operate the LDX-3200 Series instrument from a single phase power source delivering nominal line voltages of 100, 120, 220, or 240 VAC (all values RMS), at 50/60 Hz. The line power voltage can vary $\pm 10\%$ but cannot exceed 250 VAC. Maximum power consumption is 60 VA (Volt-Amps). The instrument's operational voltage is factory configurable and need not be changed before operating the instrument. However, check to be sure that the voltage printed on the back panel of the instrument matches the power-line voltage in your area.

WARNING

Before connecting the LDX-3200 Series Precision Current Source to a power source, verify that the AC power source matches the setting of the LDX-3200's voltage printed on the rear panel of the instrument.

To avoid electrical shock hazard, connect the instrument to properly earth-grounded, 3-prong receptacles only. Failure to observe this precaution can result in severe injury or death.

GPIB Connector

The IEEE 488.2 GPIB interface connector is located on the rear panel, directly above the power input module and fuse. See Figure 1.2, LDX-3200 Series Rear View. Attach the GPIB cable to the 24-pin connector located on the rear panel. The connector is tapered to ensure proper orientation. Using your fingers, tighten the two screws on the cable connector.

A total of 15 devices can be connected together on the same GPIB interface bus. The cables have single male/female connectors on each end so that several cables can be stacked. This allows more than one cable to be attached to any one device. However, the maximum length of the GPIB cables must not exceed 20 meters (65 feet) total, or 2 meters (6.5 feet) per device.

The GPIB Address

The talk and listen addresses on the LDX-3200 Series Precision Current Source are identical. This GPIB address is read locally by pressing the (GPIB) **LOCAL** switch with the address displayed on the LCD display. The instrument comes from the factory configured with the GPIB address set to 1. You can change the LDX-3200's GPIB address locally (via front panel). A procedure for changing the address can be found in the section "Changing the GPIB Address" in Chapter 3.

Tilt-Foot Adjustment

The LDX-3200 Series Precision Current Source comes standard with folding front legs and two rear feet for use as a bench top instrument. Extending the front feet so that the instrument front panel sits up makes it easier to view the LED displays. To use them, place the unit on a stable base and rotate the front legs downward until they lock into position.

Operating the LDX-3200 Precision Current Source

Now that the LDX-3200 Precision Current Source is installed and ready for use, you can begin to learn about its operation. The following figures are photographic copies showing the functional keypad groupings, back panel connectors, and so on. Use these figures to familiarize yourself with the LDX-3200. After that, use Chapter 2 for fundamentals of operating your instrument.

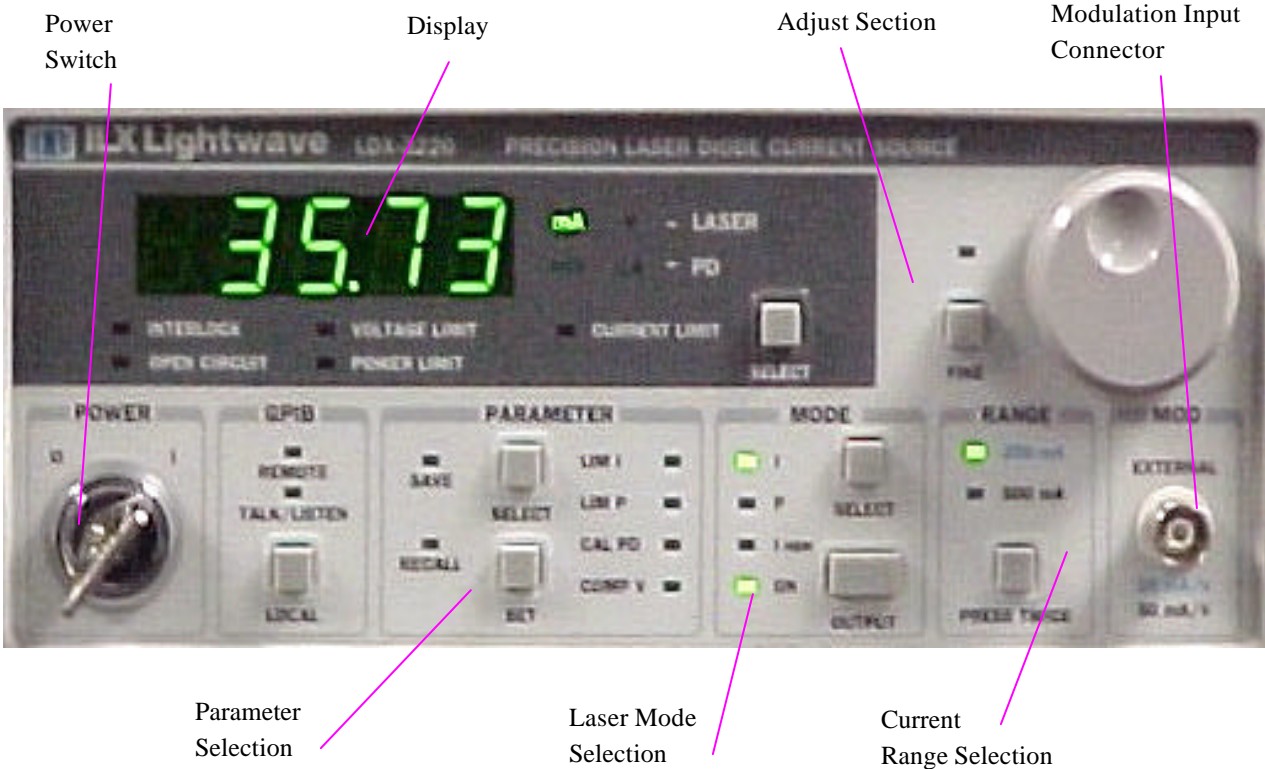

FIGURE 1.1 LDX 3200 Series Front View

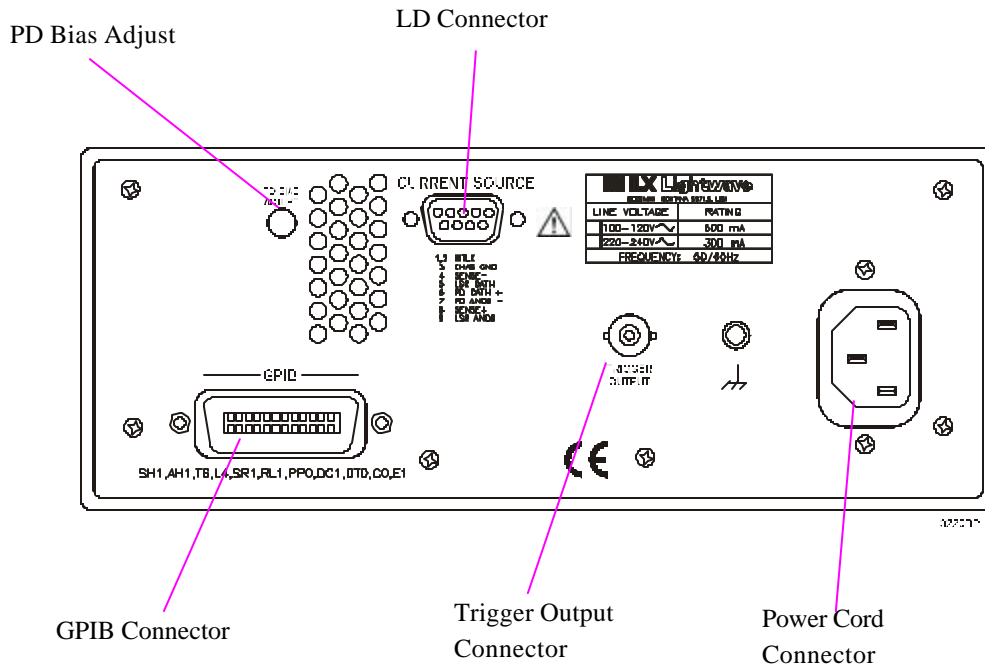

FIGURE 1.2 LDX-3200 Series Rear View

MAINTENANCE

This section covers information on how to obtain repair services.

WARNING

Potentially lethal voltages exist within the LDX-3200 Series Precision Current Source. To avoid electric shock, do not perform any of the maintenance on the instrument unless you are qualified to do so. Qualified service personnel are required to wear protective eyeglasses and anti-static wristbands while working on the LDX-3200 Series Precision Current Source circuit boards. High voltages are present on and around the instrument's printed circuit boards.

HOW TO OBTAIN REPAIR SERVICES

You may have to return your instrument to the ILX Lightwave facility at some time for repair or service whether it is under warranty or not. There is a charge for repairs after the warranty period has expired. Contact an ILX Lightwave service representative for shipping instructions prior to returning the instrument. Have the model number, instrument serial number and a description of the problem or request at the time of the call. All ILX Lightwave instruments are identified by a serial number located on the rear panel. The first four or five digits are the model number, the last four digits are unique to the instrument and identify your instrument specifically. A return authorization number will be given to you at the time of your request for repair or service. Please use this number in all communications concerning your instrument.

General Shipping Instructions

If you need to ship your LDX-3200 Precision Current Source back to the factory for repair, be sure that the LDX-3200 is packaged in an enclosure with cushioning material to prevent damage to the instrument during shipment (use the original shipping containers and accessories if possible). Re-install the ESD protective caps on the rear and front panels over the connectors (9 pin D, BNC, and GPIB). Shipping damage is not covered under warranty.

Attach a tag to the instrument identifying the owner and indicating the service or repair needed. Include the model number and serial number. We suggest that you insure the shipment.

In North America, contact ILX Lightwave for return authorization and shipping instructions. Outside of North America, contact your ILX distributor for the shipping information.

LDX-3200 SERIES SPECIFICATIONS

Laser Current Source Specifications

Model Number	LDX-3210		LDX-3220	
DRIVE CURRENT OUTPUT ¹				
Output Current Range:	0 to 50 mA	0 to 100 mA	0 to 200 mA	0 to 500 mA
Set-Point Resolution:	1 μ A	2 μ A	4 μ A	10 μ A
Set-Point Accuracy (% of FS):	$\pm 0.05\%$	$\pm 0.05\%$	$\pm 0.05\%$	$\pm 0.05\%$
Compliance Voltage:	0 - 10 V, adjustable	0 - 10 V, adjustable	0 - 10 V, adjustable	0 - 10 V, adjustable
Temperature Coefficient:	<50 ppm/ $^{\circ}$ C	<50 ppm/ $^{\circ}$ C	<50 ppm/ $^{\circ}$ C	<50 ppm/ $^{\circ}$ C
Short-Term Stability (1 hr.): ²	<10 ppm	<10 ppm	<10 ppm	<10 ppm
Long-Term Stability (24 hr.): ³	<20 ppm	<20 ppm	<20 ppm	<20 ppm
Noise and Ripple (μ A rms) ⁴				
High Bandwidth Mode:	<1.5 μ A	<1.5 μ A	<4 μ A	<4 μ A
Low Bandwidth Mode:	<1.5 μ A	<1.5 μ A	<2 μ A	<2 μ A
Transients				
Operational: ⁵	<1 mA	<1 mA	<1 mA	<1 mA
1kV EFT/Surge: ⁶	<5 mA/< 8 mA	<5 mA/< 8 mA	<8 mA/< 12 mA	<8 mA/< 12 mA
COMPLIANCE VOLTAGE ADJUST				
Range:	0 - 10 V	0 - 10 V	0 - 10 V	0 - 10 V
Resolution:	50 mV	50 mV	50 mV	50 mV
Accuracy:	$\pm 2.5\%$	$\pm 2.5\%$	$\pm 2.5\%$	$\pm 2.5\%$
DRIVE CURRENT LIMIT SETTINGS				
Range:	1 to 50.5 mA	1 to 101 mA	1 to 202 mA	1 to 505 mA
Resolution:	0.25 mA	0.5 mA	1 mA	2.5 mA
Accuracy:	± 0.5 mA	± 1 mA	± 2 mA	± 5 mA
PHOTODIODE FEEDBACK				
Type:	Differential	Differential	Differential	Differential
PD Reverse Bias :	0 - 5V, adjustable	0 - 5V, adjustable	0 - 5V, adjustable	0 - 5V, adjustable
PD Current Range :	5 to 5000 μ A	5 to 5000 μ A	5 to 5000 μ A	5 to 5000 μ A
Output Stability: ⁷	$\pm 0.02\%$	$\pm 0.02\%$	$\pm 0.02\%$	$\pm 0.02\%$
Accuracy, set point (% of FS):	$\pm 0.05\%$	$\pm 0.05\%$	$\pm 0.05\%$	$\pm 0.05\%$
EXTERNAL ANALOG MODULATION				
Input:	0-10V, 10k Ω	0-10V, 10k Ω	0-10V, 10k Ω	0-10V, 10k Ω
Transfer Function:	5 mA/V	10 mA/V	20 mA/V	50 mA/V
Bandwidth (3 dB)				
High Bandwidth: ⁸	DC to 1 MHz	DC to 1 MHz	DC to 1 MHz	DC to 1 MHz
Low Bandwidth: ⁹	DC to 15 kHz	DC to 15 kHz	DC to 15 kHz	DC to 15 kHz
TRIGGER OUTPUT				
Type:	TTL	TTL	TTL	TTL
Pulse Width:	13 μ S	13 μ S	13 μ S	13 μ S
Delay:	12 mS	12 mS	12 mS	12 mS
MEASUREMENT (DISPLAY)				
Output Current Range:	0 to 50.000 mA	0 to 100.00 mA	0 to 200.00 mA	0 to 500.00 mA
Output Current Resolution:	0.001 mA	0.002 mA	0.01 mA	0.01 mA
Output Current Accuracy:	$\pm 0.05\%$ FS	$\pm 0.05\%$ FS	$\pm 0.05\%$ FS	$\pm 0.05\%$ FS
Photodiode Current Range:	0 to 5,000 μ A	0 to 5,000 μ A	0 to 5,000 μ A	0 to 5,000 μ A
Photodiode Current Resolution:	1 μ A	1 μ A	1 μ A	1 μ A
Photodiode Current Accuracy:	± 2 μ A	± 2 μ A	± 2 μ A	± 2 μ A
PD Responsivity Range: ¹⁰	0.00 to 1000.00 μ A/mW	0.00 to 1000.00 μ A/mW	0.00 to 1000.00 μ A/mW	0.00 to 1000.00 μ A/mW
PD Responsivity Resolution:	0.01 μ A/mW	0.01 μ A/mW	0.01 μ A/mW	0.01 μ A/mW
Optical Power Range:	0.00 to 101.00 mW	0.00 to 101.00 mW	0.00 to 505.00 mW	0.00 to 505.00 mW
Optical Power Resolution:	0.01 mW	0.01 mW	0.01 mW	0.01 mW
Forward Voltage Range:	0.000 to 10.000 V	0.000 to 10.000 V	0.000 to 10.000 V	0.000 to 10.000 V
Forward Voltage Resolution:	1 mV	1 mV	1 mV	1 mV
Forward Voltage Accuracy: ¹¹	± 2 mV	± 2 mV	± 2 mV	± 2 mV

1 All values relate to a one-hour warm-up period.

2 Over any 1-hour period, half-scale output.

3 Over any 24-hour period, half-scale output.

4 Measured optically, evaluating noise intensity of a laser diode into a photodetector with 150 kHz bandwidth. Request ILX Application Note #3.

5 Maximum output current transient resulting from normal operational situations (e.g., power on-off, current on-off), as well as accidental situations (e.g., power line plug removal).

6 Maximum output current transient resulting from a 1000 V power-line transient spike. Tested to ILX Lightwave Technical Standard #LDX-00196. Request ILX Application Note #3.

7 Maximum monitor photodiode current drift over any 30 minute period. Assumes zero drift in responsivity of photodiode.

8 300 mA set point, 60 mA modulation current.

9 Small signal specification is for typ. 10% modulation depth. Large signal spec. assumes 50% modulation depth at mid-scale output.

10 Responsivity value is user-defined and is used to calculate the optical power.

11 Four wire voltage measurement at the load. Voltage measurement accuracy while driving calibration load. Accuracy is dependent upon load and cable used.

GENERAL

Size (H x W x D)	4" x 8.5" x 13.4", 102 mm x 216 mm x 340 mm
Weight	
LDX-3210	approx 12 lbs (5.5 kg)
LDX-3220	approx 12 lbs (5.5 kg)
Power (50-60 Hz)	100 V, ±10%
	120 V, ±10%
	220 V, ±10%
	230-240 V, ±10%
Temperature	0 to +40 °C operating; -40 to +70 °C storage
Humidity	< 90 % relative humidity, non-condensing.
Laser Safety Features:	Key switch, interlock and output delay (meets CDRH US21 1040.10)
Display type:	5-digit, green LED

AVAILABLE OPTIONS AND ACCESSORIES

Options and accessories available for the LDX-3200 Series Precision Current Sources include the following:

<u>DESCRIPTION</u>	<u>MODEL NUMBER</u>
Rack mount flange kit	Tba
Temperature Controlled Laser Diode Mount	LDM-4407
Temperature Controlled Laser Diode Mount (available with collimating assembly)	LDM-4412
DIL Laser Diode Mount	LDM-4982
Butterfly Laser Diode Mount	LDM-4894
High Power Laser Diode Mount	LDM-4442
Current Source Interconnect Cable (unterminated)	CC-306S
Current Source Interconnect Cable (terminated)	CC-305S

Other Laser Diode Mounts are available. Please contact ILX Lightwave for information on additional options for your applications.

CHAPTER 2	1
HOW TO OPERATE YOUR LDX-3200	1
INTRODUCTION	1
APPLYING POWER TO YOUR LDX-3200	1
The Power-On Sequence	1
The Power-On State	1
CONNECTING TO THE LASER	2
Interlock Connections	4
Photodiode Connections	4
Setting the PD bias	4
Grounding considerations	4
FRONT PANEL OPERATION	5
The Display	5
OPERATING A LASER IN CONSTANT CURRENT, "I" MODE	5
Setting Up the Precision Current Source	5
Conditions Which Will Automatically Shut Off the LASER OUTPUT	6
OPERATING A LASER IN CONSTANT POWER MODE, P	7
Entering Photodiode Responsivity values	7
ERROR INDICATORS	8

Chapter 2

HOW TO OPERATE YOUR LDX-3200

INTRODUCTION

This chapter introduces you to the operation of the LDX-3200 Series Precision Current Source. It offers instructions for connecting your laser to the current source, and describes powering up the instrument. This chapter also contains step by step procedures that teach you how to operate your current source in Constant Current Mode and Constant Power Mode. We recommend that you review the contents of this chapter at a minimum before operating the LDX-3200 Series Precision Current Source.

APPLYING POWER TO YOUR LDX-3200



To turn on the LDX-3200, rotate the key in the “POWER” section of the front panel from “O” to “I”. This action will initiate the power on sequence. If the LDX-3200 does not appear to turn on, verify that it is connected to line power. If line power is not the problem, remove the power cord and check the line power fuse.

The Power-On Sequence

During the power-up sequence, the following takes place. For about three seconds all indicators light up, and all of the 7-segment displays indicate "8". Then all lamps are turned off for three seconds. Next, the firmware version will be displayed. Then, a self-test is performed to ensure that the instrument's hardware and processor are communicating. After this test, the instrument is ready to operate, and is configured to the state it was in when the power was last shut off.

The Power-On State

You can choose to "clear" the last saved state by recalling the default values. These values are stored in BINS to which you can save or recall instrument configurations (described in more detail in Chapter 5). "BIN 0" contains all of the default configurations listed in Table 2.1.

NOTE

If the instrument cannot successfully complete the power on test, an error message of E-512 or E-513 will be displayed on the Display. See Chapter 3 for a list of error codes and actions to take when your instrument indicates these errors.

LDX-3200 Series DEFAULT CONFIGURATION

**GPIB mode in LOCAL via front panel, or in REMOTE via GPIB
PARAMETERS not selected
CAL PD = 0 mA/mW
LIM I (high range) = 125 mA (LDX-3220), 25 mA (LDX-3210)
LIM I (low range) = 50 mA (LDX-3220), 12.5 mA (LDX-3210)
LIM V = 10 volts
LIM P = 1000 mW (LDX-3220), 200 mW (LDX-3210)
LASER output off
LASER DISPLAY enabled, in I mode
Constant I, low bandwidth mode selected
LASER display showing actual current (0.00 with output off)
LASER STEP value = 1 (see LAS:STEP command, chapter 4)
LASER Tolerance values = 1.00 mA, 1.0 seconds
LASER I Set Point = 0 mA
LASER I_{td} Set Point = 0 mA
LASER P_{td} Set Point = 0 mW
RECALL BIN number = 0
MODULATION Enabled**

Table 2.1 LDX-3200 Series Default Settings

CONNECTING TO THE LASER

When connecting your laser or any other sensitive devices to the LDX-3200 Series Precision Current Source, we recommend that the instrument be powered up and the **LASER** output be off (**MODE**) **ON** LED unlit. In this condition, a low impedance shunt is active across the output terminals. When disconnecting devices, it is only necessary to turn the current source output off.

It is also recommended that the connections to the LDX-3200 Series Precision Current Source output be made using twisted wire pairs with an earth-grounded shield (see Figures 2.1 A - D). The output terminals of the instrument are left floating relative to earth ground to suppress AC power-on/power-off transients that may occur through an earth-ground path. If the output circuit is earth-grounded at some point (such as through the laser package and mount), the user must be careful to avoid multiple earth grounds in the circuit. Multiple earth grounds may provide circuit paths that induce spurious currents in the photodiode feedback circuit and output leads.

IMPORTANT

Experience indicates that should an open circuit occur during laser operation (while the LASER is ON), the laser may be damaged by a momentary circuit break-and-remake before the final circuit break. The cable connections to the laser must be secure enough that they will not open-circuit, should they be jostled or bumped.

Figures 2.1A - D show the possible configurations of connecting laser diodes and photodiodes with the LDX-3200 Series Precision Current Source.

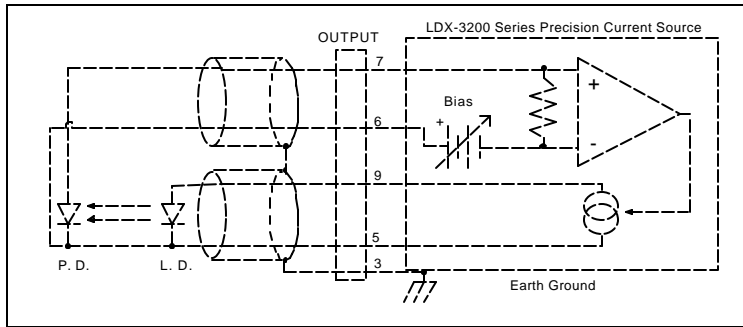

Figure 2.1A Common Laser Cathode - Photodiode Cathode

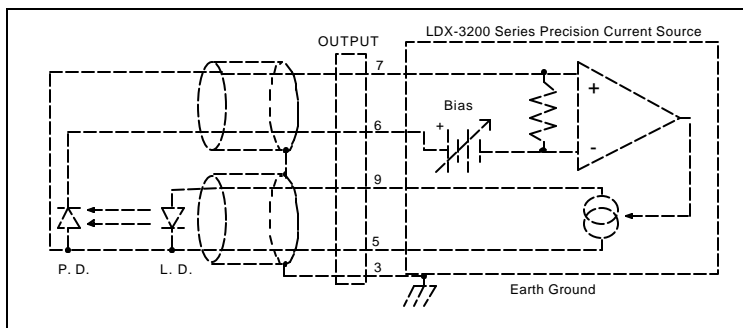

Figure 2.1B Common Laser Cathode - Photodiode Anode

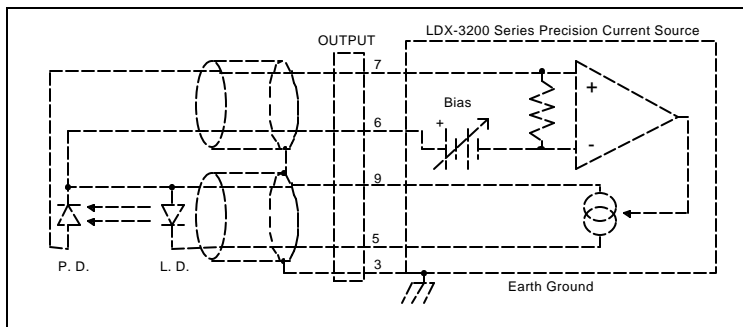

Figure 2.1C Common Laser Anode - Photodiode Cathode

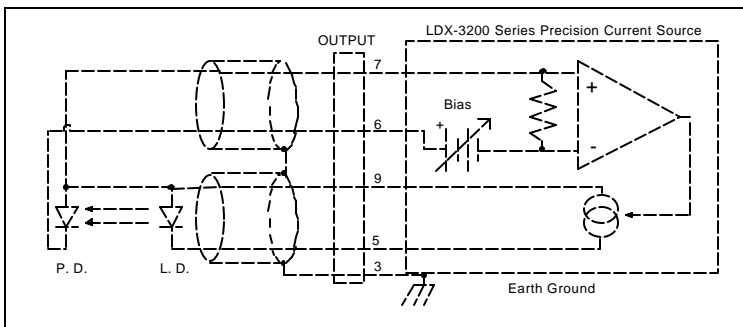

Figure 2.1D Common Laser Anode - Photodiode Anode

The 9-pin connector marked CURRENT SOURCE on the back panel is used to connect your laser diode to the LDX-3200. There are connections provided for laser cathode and anode, photodiode cathode and anode, chassis ground and interlock. The pinout diagram for this connector is shown in Figure 2.2.

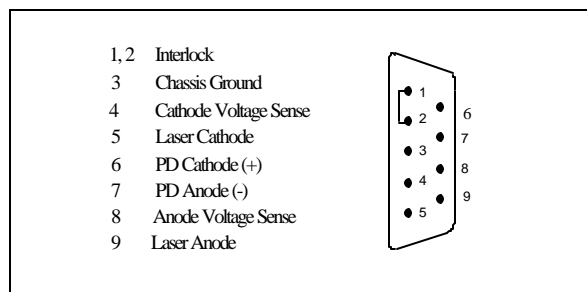

Figure 2.2 Back Panel LD Connector

Interlock Connections

In order for the laser output to be enabled a short circuit must exist between the Interlock pins (pins 1 and 2) of the connector. The short can be a direct short across the pins or a switch to prevent laser operation until the switch is closed. If a short does not exist between these two pins, the INTERLOCK LED will illuminate on the front panel and the laser output will be disabled.

CAUTION

The interlock terminals on the LASER connector, pins 1 and 2, must be kept isolated from all other connections including earth ground.

Photodiode Connections

Many laser diode modules contain an internal photodiode that monitors the back-facet emission of the laser. Usually, this photodiode is internally connected to either the laser anode or cathode.

The photodiode and laser connections to the LDX-3200 Series Precision Current Source are electrically isolated from ground and each other. So, if a 4-pin connection is made (no common connections) no additional jumpers are required. Figures 2.1A - 2.1D show the recommended connections and shielding for 3-pin lasers (where the common connection is internal to the device). A 4-pin laser should be connected with the same shielding as shown in Figure 2.1, but the common connection (between the photodiode and the laser) is optional.

Setting the PD bias

The LDX-3200 Series Precision Current Source provides an adjustable reverse bias of 0 - 5 VDC for the photodiode. To set the photodiode bias to 5 volts reverse bias, turn the back panel PHOTODIODE BIAS ADJUST fully clockwise. To set the photodiode bias to 0 volts reverse bias, turn the back panel PHOTODIODE BIAS ADJUST fully counter-clockwise

Grounding considerations

The LASER outputs of the LDX-3200 Series Precision Current Source are isolated from chassis ground allowing either output terminal to be grounded at the user's option. Figure 2.1 shows the proper earth-ground shielding for laser diode/photodiode connections.

FRONT PANEL OPERATION

This section describes fundamentals of operation for your LDX-3200 Series Precision Current Source in two operating modes, Constant Current (I), and Constant Power (P).

The Display



The digital display is used to show control parameters such as laser drive current (mA), laser current limit (mA), laser forward voltage (V), voltage limit (V), monitor photodiode current (μA), and laser optical power (mW) in both set point and measurement modes. It will also display error codes that relate to LASER operation. Error indicators

underneath the display indicate control errors and are explained in the section titled “ERROR INDICATORS”. All laser control parameters are displayed on this digital display with the appropriate annunciator illuminated.

OPERATING A LASER IN CONSTANT CURRENT, “I” MODE

Suppose you have an LDX-3220 and you want to run the instrument in Constant Current, low bandwidth mode, with a set point of 150 mA and a current limit of 175 mA. This particular mode uses a low-pass filter on the laser drive current output to significantly reduce noise. In this mode a modulation input of up to 15 kHz may be used, via the front panel MOD EXTERNAL connector. Follow the instructions below in the sequence presented.

Setting Up the Precision Current Source



Set the LDX-3200 in Constant Current, low bandwidth mode by selecting **I** in the **MODE** section of the front panel. Do this by toggling the **SELECT** push button until the **I** indicator is illuminated. Repeatedly pressing the (MODE) **SELECT** switch cycles through the current (**I**), light power (**P**), or high-bandwidth current (**I_{HBW}**) control modes.



Next, in the **RANGE** section set the current source range by selecting the 200 mA range indicated by the accompanying LED. You will need to press the **SELECT** push button twice to change the range. It must be pressed twice quickly (within less than 1 second) to switch between ranges, and the LASER output must be off (LASER MODE ON indicator unlit) in order to change ranges.

Configure the display so that it reads laser current in mA. Press and release the **SELECT** switch in the **DISPLAY** section of the front panel until the mA annunciator is lit. The (DISPLAY) **SELECT** switch is also used to select the **I_{PD}** (photodiode current, μA), **P_{PD}** (laser power, mW), or **V** (forward voltage, V) measurement or set point display modes. When the set point mode is active, the corresponding annunciator will flash to indicate set point rather than measurement display.

To just view the set point, press and hold down the display **SELECT** switch for two or more seconds. When the **SELECT** switch is released the previous measurement mode will be restored.

At this point the LDX-3200 Series current source is in Constant Current Mode, (I), in the 200 mA range, and the display is reading in mA. Next, we need to adjust the set point of the laser current source.

To adjust the set point of the current source to 150 mA, turn the adjust knob to vary the set point. When the adjust knob is turned, the LDX-3200 automatically changes to set point mode indicated by the flashing annunciator. Adjust the set point to 150 mA. After an adjustment has been made, and the adjust knob is released, the set point mode will time out in three seconds. The display will revert to the original measurement display mode (**I**, **I_{PD}**, **V**, or **P_{PD}**).

We're not quite ready to turn on the laser. One of the laser protection features our precision current sources offer is a fully independent hardware current limit. The current limit protects your laser by never allowing the laser drive current to exceed the limit independent of the set point and the output control mode (Constant Current or Constant Power).



To set the current source limit, use the **SELECT** push button in the **PARAMETER** section of the front panel to select **LIM I**. Press and hold the (PARAMETER) **SET** push button and rotate the adjust knob to vary the limit set point value. Set the limit to 175 mA. Once the (PARAMETER) **SET** push button is released, the new parameter value is stored in non-volatile memory.

When the LASER current limit is reached, the **CURRENT LIMIT** error indicator flashes. The current limit setting is independent of the voltage drop of the device connected to the LASER output, and therefore, no dummy load is required for precise adjustment of the current limit. Furthermore, since the current limit circuitry is fully independent of the main current control, the current limit can be adjusted safely, even while the LASER output is active.

An additional feature of the LDX-3200 Series instruments is an adjustable voltage limit. This allows an extra level of laser protection in the event of an intermittent open circuit. For maximum protection via the fastest open-circuit detection, the voltage limit should be set to a value slightly greater than the intended operating voltage.

To set the LASER voltage limit, use the **SELECT** push button in the **PARAMETER** section of the front panel to select **COMP V** and then press and hold the (PARAMETER) **SET** push button. While holding the (PARAMETER) **SET** push button, adjust the voltage limit using the adjust knob.

Now you are ready to enable the current source output for your laser diode.



In the **MODE** section of the front panel, press the push button labeled **OUTPUT**. The accompanying LED labeled **ON** will illuminate, indicating that the laser current source's output is enabled. The instrument will drive the current source to the value set by the corresponding **MODE** set point. When the LASER output is off, an internal short is placed across the LASER output. The **OUTPUT** switch has a toggling action. Pressing the switch again will disable the current source output and the **ON** LED will not be illuminated. The default condition for the current source output is off when the instrument is first powered up.

With the laser output enabled, the LASER display should be indicating measured laser current. If the output won't function, check the following conditions:

Conditions Which Will Automatically Shut Off the LASER OUTPUT

The following conditions will automatically cause the instrument to disable the current source output:

1. LASER High Power Limit
2. LASER Interlock/Key Lock turned off
3. LASER Open Circuit or Voltage Limit

OPERATING A LASER IN CONSTANT POWER MODE, P

Suppose you want to operate a 3 mW laser at constant 1 mW level. The LDX-3200 Series instrument allows you to operate the laser current source driver in a Constant Power mode. In this mode, the LDX-3200 Series instrument drives current to the laser to reach a set point power value (in mW). The control loop feedback parameter is photodiode current that the LDX-3200 converts to optical power via a user-defined photodiode responsivity number. If laser power changes due to internal or environmental conditions, the LDX-3200 will increase/decrease the current to the laser to maintain the power set point. The following paragraphs detail the instrument configuration in Constant Power Mode.



To set the LDX-3200 in Constant Power mode, select **P** in the **MODE** section of the front panel by toggling the **SELECT** push button. Repeatedly pressing the (MODE) **SELECT** switch cycles through the current (**I**), light power (**P**), or high bandwidth current (**I_{HBW}**) control modes. The LED indicator shows the selected mode.

Entering Photodiode Responsivity values



The photodiode responsivity, **CAL PD**, is used to convert between photodiode current and optical power of the laser diode. To enter the **CAL PD** parameter, select **CAL PD** with the (PARAMETER) **SELECT** push button by toggling down past **LIM P**. The indicator becomes lit when **CAL PD** is selected and the display indicates the responsivity parameter in $\mu\text{A}/\text{mW}$ (not enunciated). Rotate the adjust knob while holding the (PARAMETER) **SET** push button to enter a new value for responsivity. When the correct value is displayed, store the number by releasing the (PARAMETER) **SET** pushbutton.

A method to calculate the responsivity is suggested below.

1. Measure (with a calibrated detector) the output power of the device.
2. Measure the corresponding photodiode current.
3. Calculate the responsivity by dividing the photodiode current by the optical power noting the units required are $\mu\text{A}/\text{mW}$.

The LDX-3200 Series Precision Current Source can be put into a special mode with the **CAL PD** parameter set to zero. When the **CAL PD** value is zero, the LASER output will be controlled to the **I_{PD}** set point value. Therefore, the instrument is in Constant **I_{PD}** mode. The display will indicate "-.-" for the power measurement.

Next, configure the display so that it reads in **mW** by pressing and releasing the (DISPLAY) **SELECT** switch until the **mW** annunciator is lit.

Adjust the Constant Power set point of the LDX-3200 to 1.00 mW. To do this, turn the adjust knob to vary the set point. When the adjust knob is turned, the LDX-3200 automatically changes to set point mode as indicated by the flashing annunciator. Adjust the set point to 1.00 mW. After an adjustment has been made, and the adjust knob is released, the set point mode will time out in three seconds. The display will then return to the measurement display mode (**I**, **I_{PD}**, **V**, or **P_{PD}**).

Before the laser output is enabled, the power limit for the laser under test should be set. In Constant Power mode, this is accomplished by setting a Power limit, **LIMP** value. The LDX-3200 uses the responsivity value entered to calculate a power limit as a function of monitor current (**I_{PD}**). This is a software limit only.

To set the Constant Power limit, use the **SELECT** push button in the **PARAMETER** section to select **LIM P**. When the **LIM P** is indicated by the accompanying LED, the display will indicate the limit set point in **mW**. Press and hold the (PARAMETER) **SET** push button and rotate the adjust knob to set the limit to 1.50 mW. When the desired value is reached, release the (PARAMETER) **SET** push button to store the new limit value.

The **LIM P** is the absolute limit of optical power, as detected by the unit via the monitor PD feedback loop. In order for this limit to be meaningful, the monitor photodiode responsivity (**CAL PD**) must be adjusted correctly. This limit is a software limit only. The **LASER** output is normally turned off if this limit is reached (See **LASer:ENABLE:OUTOFF** command in Chapter 4 for instructions on disabling this function). The maximum **LIM P** value is 100.0 mW (LDX-3210), and 500.0 mW (LDX-3220).

Also, in constant power mode the **LASER** current limit and voltage limit values are in effect. Refer to the discussion on page 8 that describes how to set these limits.



Now the instrument is configured to operate in Constant Power Mode. In the **MODE** section, enable the output of the laser current source by depressing the **OUTPUT** push button once. The accompanying led labeled **ON** will illuminate indicating that the laser output is on and current is being driven to the laser. The LDX-3200 current source will drive the laser to the Constant Power set point and maintain closed loop control with the PD current measurement.

ERROR INDICATORS

The LDX-3200 Series Precision Current Sources indicate general operational error conditions. Each error condition results in an action as shown in the following table.

ERROR INDICATORS

<u>Error Condition</u>	<u>Action</u>
Interlock	Output off, INTERLOCK light flashes at 1 Hz
Open circuit	Output off, OPEN CIRCUIT light flashes at 1 Hz. If this condition was caused by an excessively high compliance voltage, the VOLTAGE LIMIT light will also be turned on.
Current limit	CURRENT LIMIT light flashes at 1 Hz
Voltage limit	VOLTAGE LIMIT light flashes at 1 Hz. This indicator warns that the output is within 0.25 volts of LIM V setting. If the voltage limit (LIM V) is reached, the LASER output will shut off.
Optical Output Power Limit	Output off, POWER LIMIT light flashes at 1 Hz

Table 2.2 LDX-3200 Error Indicators

CHAPTER 3	1
OPERATING IN REMOTE CONTROL	1
INTRODUCTION	1
Reading the GPIB Address	1
Changing the GPIB Address	1
Changing Operation from Local to Remote	1
LDX-3200 SERIES CURRENT SOURCE COMMAND SET	2
Command Syntax	2
Command Paths	4
IEEE488.2 Common Commands	5
LDX-3200 Current Source Often Used Commands	6
STATUS REPORTING	7
Event and Condition Registers	7
Operation Complete Definition	7
Output Off Register	9
Command Timing and Completion	10
Error Messages	11

CHAPTER 3

OPERATING IN REMOTE CONTROL

INTRODUCTION

Everything you learned to do from the front panel can also be done remotely and in some cases with more flexibility. For instance, in remote mode, you have access to commands for functions not found on the front panel, such as commands that will increment (INC) and decrement (DEC) the current set point by a pre-defined step value. The following sections show you the fundamentals of operating your LDX-3200 Series Precision Current Source remotely through the GPIB interface.

Reading the GPIB Address

Before you can operate the LDX-3200 instrument from a remote location, you need to know its GPIB address. Simply press the LOCAL switch in the section labeled GPIB on the front panel. The instrument will display the address. The default address from the factory is address “Adr 01”.

Changing the GPIB Address



Every device on the GPIB bus must have a unique address. If it is necessary to change the address, press and hold in the (PARAMETER) **SET** switch while displaying the GPIB address. Turn the ADJUST knob until the desired address value is displayed, then release the SET switch. The new GPIB address will then be stored in non-volatile memory. The allowable address range is 0 - 30 for primary GPIB addressing. Extended GPIB addressing is not implemented on the LDX-3200 Series Precision Current Source at this time.

Changing Operation from Local to Remote

Sending a command over the GPIB will automatically put the instrument in REMOTE mode. The REMOTE indicator will identify when the Current Source is in remote operation mode. When the instrument is in REMOTE mode, pressing the LOCAL switch returns the instrument to LOCAL control mode unless the Local Lockout state has been activated by the host computer. Local Lockout disables all LDX-3200 Series Precision Current Source front panel switches until this condition is changed by the host computer. When the instrument is put in Local Lockout Mode by the host computer, the REMOTE indicator will flash at a 1 Hz rate to indicate that the front panel is completely disabled by Local Lockout.

The **TALK/LISTEN** indicator is illuminated when the instrument is communicating over the GPIB bus.

LDX-3200 SERIES CURRENT SOURCE COMMAND SET

For the most efficient and effective remote control of your LDX-3200 Series Precision Current Source, we recommend you study the following sections. You will learn about the LDX-3200 command sets, both IEEE488.2 Common Commands and the most used device specific commands, and command syntax. Later in this chapter you will be introduced to the error and status registers.

Command Syntax

Any command or command query must contain all of the letters which are shown in the LDX-3200 Command Path Structure, Figure 3.1. However, the Current Source's command parser is NOT CASE SENSITIVE so upper or lower case may be used in any combination. The lower case letters shown with the Device Dependent commands in Chapter 4 are optional letters and may be used for clarity. For example, the following commands are equal:

```
LAS:DIS 1  
LAS:DisP 1  
LAS:DISPLAY 1
```

In this example, only the first three letters "DIS" are required, while the other letters, "play" are optional. These optional letters must be used in the proper sequence as shown.

The syntax of the LDX-3200 Series Precision Current Source commands follows the rules laid out in the IEEE-488.2 standard. Colons (:) indicate the start of a new command path, while semicolons (;) indicate a separation of commands within a command string. A leading colon on a command may be used to return the LDX-3200 Series Precision Current Source command parser to the command path root (see Figure 3.1).

Spaces or white space may be used to separate commands and/or data (after the command header or query question mark). Spaces or white space must be used to separate the command (header) from the first parameter (or program data). The following examples show valid syntax for commands with the LDX-3200 Series Precision Current Source:

```
LAS:display:ldi  
Laser:limit:ldi 400  
LAS:DIS 1; las:set:ldi?;  
Las:MODE:Mdp; LAS:OUT 1
```

The following are examples of invalid syntax for the LDX-3200 Series Precision Current Source. These command strings would produce an erroneous result, as explained:

LAS:MODE MDP	<i>-Missing colon, MODE? expected.</i>
LAS:MODE:ILBW DEC	<i>-Missing semicolon, DEC command generates an error.</i>
LAS:DIS ?	<i>-Space not allowed before question mark, DIS command expected.</i>
Las:LDI33;dis?	<i>-Space missing between LDI command and the parameter value, 33.</i>

For further clarity in programming, the (Boolean) values of one (1) and zero (0) may be used or their names as indicated in the following table.

<u>SUBSTITUTE NAME</u>	<u>VALUE</u>
ON	1
OFF	0
OLD	1
NEW	0
TRUE	1
FALSE	0
SET	1
RESET	0

Table 3.1 Substitute Parameter Names

If multiple parameters are expected, they should be separated with commas, as in:

LAS:INC 100,50

A query has no space between the mnemonic and the question mark, as in:

LAS:LDI?

The LDX-3200 Series Precision Current Source uses a terminator of <NL><^END> (new line with EOI). For users whose GPIB driver defaults expect a carriage return in the terminator, <CR><NL><^END>, the “TERM” command may be used for convenience (see “TERM” command, Chapter 4). For more information, refer to your GPIB driver configuration manual.

The command structure is illustrated in Figure 3.1. Table 4.1 lists all of the LDX-3200 Series Precision Current Source's device-dependent commands, with the full path shown for each command and a brief explanation of its usage.

Command Paths

The LDX-3200 Series Precision Current Source device-dependent commands are structured into a tree format (see Figure 3.1). Each of the legal paths is listed below, followed by its list of path options, each of which is followed by the commands themselves. It is recommended that the first-time user begin learning the commands by using the full path notation. Once you are familiar with the commands, you may wish to take advantage of the shortcuts allowed for command paths.

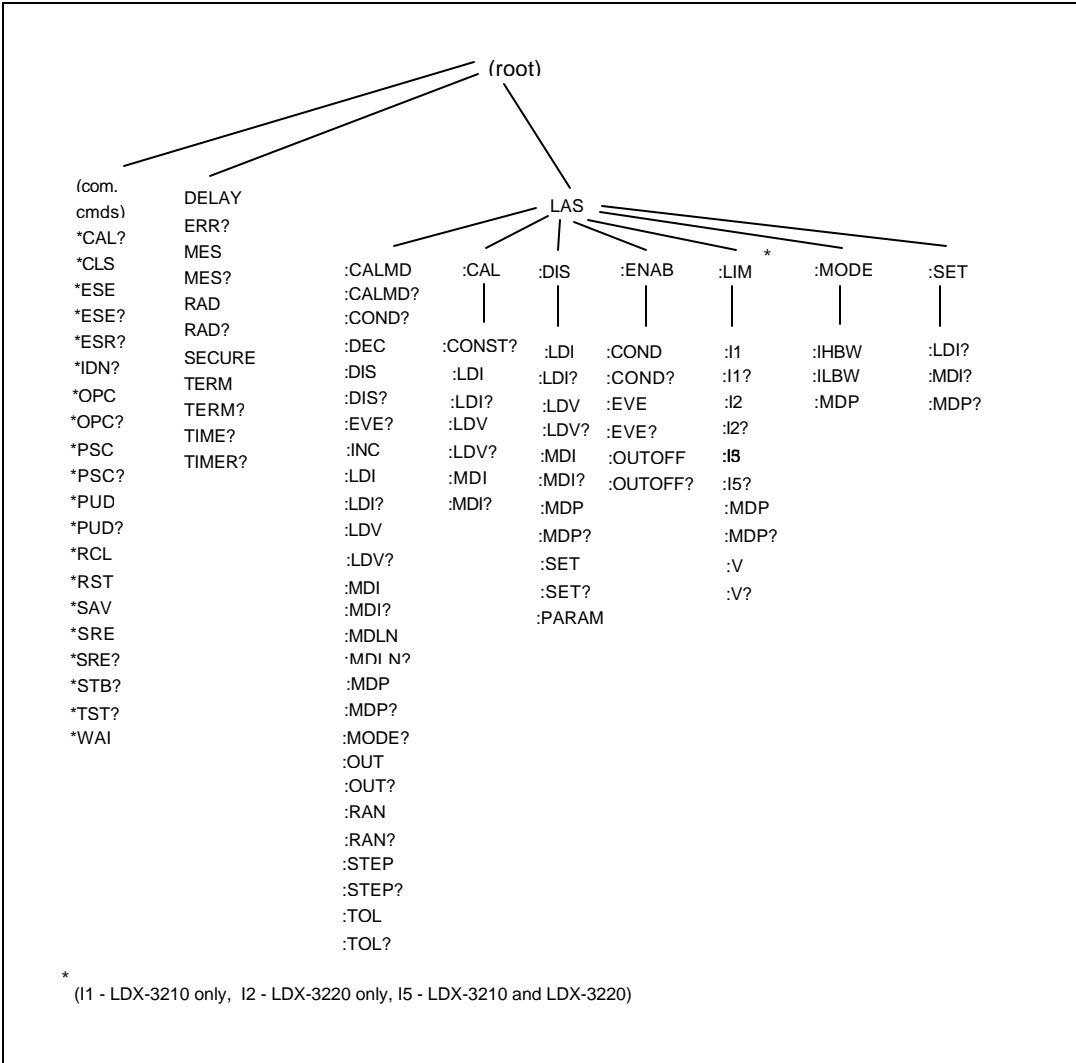
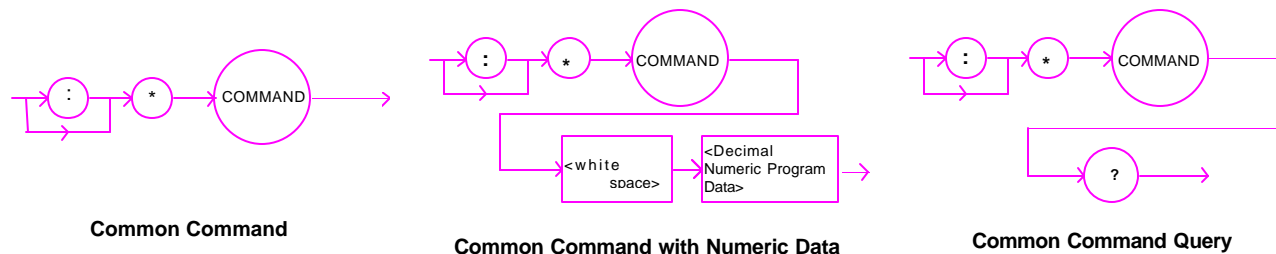

Figure 3.1 LDX-3200 Series Command Path Structure

IEEE488.2 Common Commands

The IEEE488.2 Common Commands and Queries are distinguished by the “*” which begins each mnemonic. The diagrams below show the syntax structure for common commands, common command queries, and common commands with numeric data required.



Numeric data is required with *PSC (1 = on, 0 = off), *RCL (0 to 10, see front panel RECALL function), *SAV (1 to 10, see front panel SAVE function), *ESE (0 to 255, see Figure 3.2), *SRE (0 to 255, see Figure 3.2), and *PUD (used at factory only).

A list of all of the IEEE 488.2 Common Commands supported by the LDX-3200 Series follows.

*CAL?	*CLS	*ESE
*ESE?	*ESR?	*IDN?
*OPC	*OPC?	*PSC
*PSC?	*PUD	*PUD?
*RCL	*RST	*SAV
*SRE?	*SRE	*STB?
*TST?	*WAI	

For more information on these commands, refer to an ANSI/IEEE 488.2-1987 standards reference.

NOTE

*Care should be taken to set the GPIB time-out appropriately for use with the *WAI, DELAY, or *OPC? Commands. If the time for a response after one of these commands exceed the GPIB time-out period, a bus (timeout) error will occur. Usually, after this timeout error, the LDX-3200 Series Instrument will generate a query error (E302). This error code is reported via the ERR? Query.*

LDX-3200 Series' Often Used Commands

The LDX-3200 Series Precision Current Source's complete command set contains over 60 commands that allow you to operate the Current Source for a variety of applications. Within the command set, however, is a smaller subset of commands that will meet most of your needs. These commands are listed in Table 3.2.

LDX-3200 OFTEN-USED COMMANDS

NAME	PARAMETERS	FUNCTION
ERR?	NONE	Returns errors generated since the last query.
LAS:CALMD	1	Used to set the CAL PD (monitor responsivity) constant.
LAS:LDI	1	Used to set the current source set point value.
LAS:LDI?	NONE	Used to return the constant current source measured value
LAS:LDV?	NONE	Used to return the measured laser voltage value
LAS:LIM:I1	1	Used to set the current limit (high range for LDX-3210).
LAS:LIM:I2	1	Used to set the current limit (low range for LDX-3220).
LAS:LIM:I5	1	Used to set the current limit (low range for LDX-3210, high range for LDX-3220).
LAS:LIM:MDP	1	Used to set the constant optical power (from monitor PD) limit value.
LAS:LIM:V	1	Used to set the current source compliance voltage limit value (LIM V).
LAS:MDP	1	Used to set the constant optical power set point
LAS:MDP?	NONE	Returns the actual monitor PD power value
LAS:MODE?	NONE	Returns the mode, ILBW, IHBW, or MDP (optical power).
LAS:MODE:IHBW	NONE	Sets the mode to constant current, high bandwidth mode.
LAS:MODE:ILBW	NONE	Sets the mode to constant current (low bandwidth) mode.
LAS:MODE:MDP	NONE	Sets the mode to constant optical power mode.
LAS:OUT	1	Used to enable/disable the current source output
LAS:OUT?	NONE	Returns the current source output status.
LAS:RAN	1	Sets the laser current output range.

Table 3.2 LDX-3200 Series' Often Used Commands

STATUS REPORTING

This section contains information which is relevant for understanding instrument error and status reporting. It also contains information regarding the use of the instrument status for generating interrupts for interrupt driven programs or subroutines. Understanding the Operation Complete definition for the instrument is useful for programming synchronization. The Output Off Register section also contains information on setting some of the conditions which will force the laser current source output off.

The following sections describe the Event and Condition registers, Operation Complete Flag, Output Off registers, and Error Messages.

Event and Condition Registers

In addition to the required IEEE488.2 status reporting structures, the LDX-3200 Series Precision Current Source remote interface provides Event and Condition Registers for LASER operations. The Event Registers are used to report events which occur during the operation of the LDX-3200 Series Precision Current Source. Events differ from conditions in that events signal an occurrence once, and are not reset until the Event Register is queried, the status cleared by the *CLS command, or the instrument is powered off. Conditions reflect the current state of the device, and therefore may change many times during operation. Querying a Condition Register does not change its contents.

Figure 3.2 shows the status reporting scheme of the LDX-3200 Series Precision Current Source. Each of the registers which may be accessed by a command or query has the appropriate command or query written above or below the register representation. For example, the LASER Condition Register may be queried via the "LASer:COND?" query.

The condition or event registers are logically ANDed with their respective enable registers. These bits are then logically ORed to form a summary message in the status byte for that particular register.

Operation Complete Definition

Note that Bit 0 of the Standard Event Status Register contains the status of the Operation Complete flag. Enabling this bit via the *ESE command allows the user to update bit 5 of the status byte. Then, if the SRE mask has bit 5 set, and the user issues an *OPC command, the SRQ (bus) signal will be generated upon completion of the currently processed commands. This bus signal (SRQ) may be used to initiate service request routines which depend on the completion of all previous commands.

For example, the user may turn the current source on (LAS:OUT 1), enable an SRQ on Operation Complete (set *ESE 1 and *SRE 5), and have an SRQ handling routine in the user's software which reads a new measurement after the output on state has been reached. This allows the use of the operation complete features of the LDX-3200 Series Precision Current Source, without the need for program looping or polling which can tie up the GPIB. Operation Complete on the LDX-3200 Series Precision Current Source is defined as:

- 1) No operations to the LASER current source hardware are pending.
- 2) No EEPROM (non-volatile) memory write cycles are in progress.

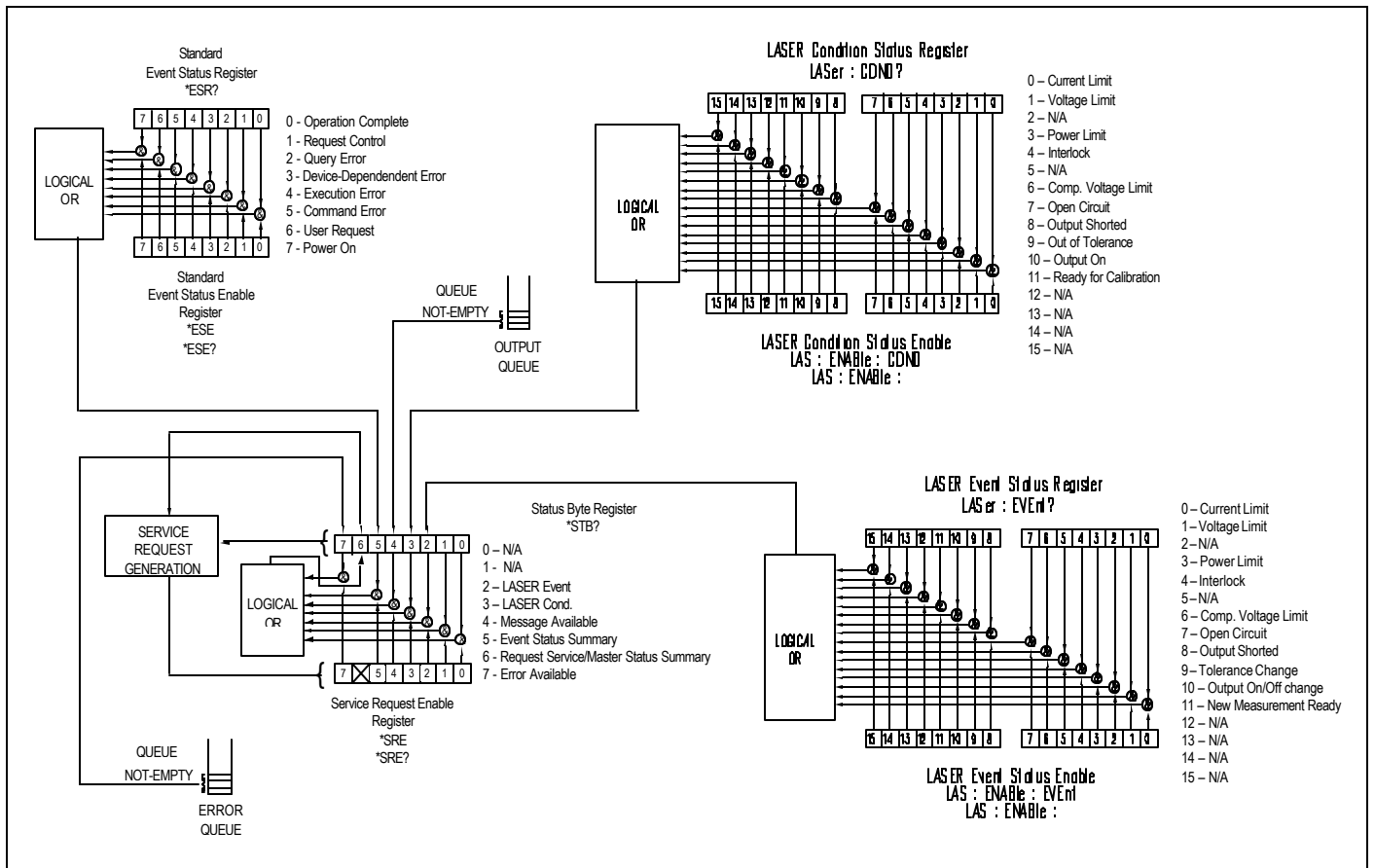

Figure 3.2 LDX-3200 Series Status Reporting Schematic Diagram

NOTE

If the GPIB times out while waiting for a response, either set the GPIB time-out longer or use SRQ generated interrupts in your program. See your GPIB manual for time-out configuration or SRQ programming setup.

*The *OPC, *OPC?, and *WAI commands should not be used inside a calibration routine.*

Output Off Register

The Output Off Enable Register allows you to determine which conditions and events in the LDX-3200 Series Precision Current Source can cause the current source output to be turned off. This register is configured in a manner which is similar to the status reporting registers. However, the register output is not reported in the Status Byte Register. Rather, it sets the hardware which controls the output switching. The events and conditions which may be set to cause the current source output to be turned off are shown in Figures 3.3.

The default (factory) settings for this register are shown in Table 3.3. These settings are not effected by the *PSC (Power-On Status Clear) command.

LDX-3200 Series OUTPUT OFF REGISTER

0- disabled	8- N/A
1- disabled	9- disabled
2- N/A	10- disabled
3- enabled	11- enabled
4- N/A	12- N/A
5- N/A	13- N/A
6- N/A	14- N/A
7- N/A	15- N/A

Table 3.3 LDX-3200 Series Default Settings for Output Off Registers

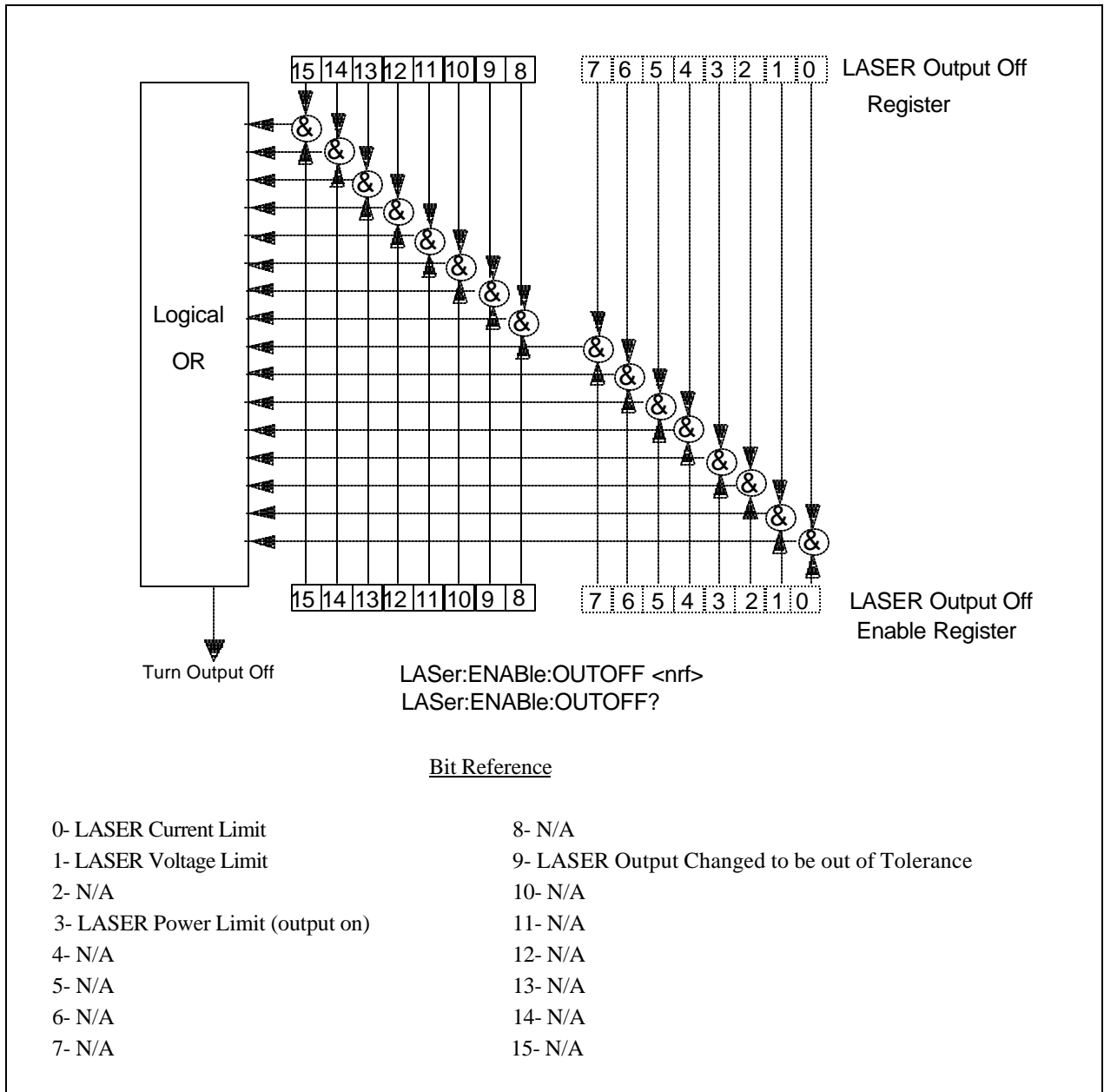

Figure 3.3 LDX-3200 Series' Output Off Register

Command Timing and Completion

This section describes, for each device-dependent command, whether that command is performed in an overlapped or sequential manner. In other words, it states whether the next command may begin while this command is being executed, or if the next command must wait until this command is completed before its execution begins. The conditions for setting the operation complete flag are given in the Chapter 3 section titled Operation Complete Definition.

All LDX-3200 Series' device-dependent commands are executed in an overlapped manner, except the "DELAY" command which is sequential. The operation complete flag is set after the conditions outlined in the Operation Complete Definition have been satisfied.

The *WAI (common command) is an example of a sequential command which forces the next command to wait until the no-operation-pending flag is true. This is essentially the same as waiting for the OPC flag to become true, because the no-operations-pending flag is used to set the OPC flag (bit 0 of the Standard Event Status Register).

Commands which change the status of the instrument limits, or change its mode or current range, step value, or status enable registers, will not have their OPC flag set until all current writing to non-volatile memory has been completed. This is done to ensure that the OPC flag is never set prematurely.

Whenever there is any output (response) data in the Output Queue, bit 4 is set in the Status Byte Register. Whenever there is any error message in the Error Queue, bit 7 is set in the Status Byte Register.

Error Messages

In the event of a hardware error condition, error messages will be displayed on the display. In most cases, the error message will appear for three seconds. In some cases the error code display will remain until the user changes display modes. In the case of multiple error messages, the display may sequentially show each message for three seconds. In addition to the hardware errors, GPIB errors may be read via the "ERR?" query. Table 3.4 lists the numerical error ranges by function. Table 3.5 contains all of the error messages which may be generated. Not all of these messages may appear on the front panel displays. Some refer to GPIB activities only.

In remote operation, the errors can be read by issuing the "ERR?" query. When this is done, all of the error messages which are resident in the error queue are returned (up to 10 may be stored). Reading the error queue via GPIB clears the error queue.

ERROR CODE CLASSIFICATIONS

<u>Error Code Range</u>	<u>Area of Operation</u>
E-001 to E-099	Internal Program Errors
E-100 to E-199	Parser Errors
E-200 to E-299	Execution Control Errors
E-300 to E-399	GPIB Errors
E-500 to E-599	LASER Control Errors

Table 3.4 Error Code Classifications

LDX-3200 Series ERROR MESSAGES

<u>Error Code</u>	<u>Explanation</u>
E-001	Memory allocation failure.
E-103	<DEFINITE LENGTH ARBITRARY BLOCK PROGRAM DATA> length too long.
E-104	<NON-DECIMAL NUMERIC PROGRAM DATA> type not defined.
E-105	<DECIMAL PROGRAM DATA> exponent not valid.
E-106	<DECIMAL PROGRAM DATA> digit expected.
E-123	Command not found.
E-124	<program mnemonic> Lookup, failed because query/command type match failed.
E-126	Too few or too many program data elements.
E-201	<PROGRAM DATA> value out of range.
E-202	<PROGRAM DATA> will not convert to valid type.
E-203	Security violation, command is not available without clearance.
E-205	<PROGRAM DATA> is not a Boolean value or word.
E-207	<PROGRAM DATA> will not convert to an unsigned 16-bit value.
E-209	<PROGRAM DATA> will not convert to an unsigned 32-bit value.
E-210	<PROGRAM DATA> will not convert to a floating point value.
E-211	<PROGRAM DATA> will not convert to a character value.
E-213	<PROGRAM DATA> is incorrect block data length.
E-214	<PROGRAM DATA> length exceeds maximum.
E-302	Query error. Device was addressed to talk, but GPIB Controller failed to read all of the <RESPONSE MESSAGE>.
E-501	LASER interlock disabled output.
E-503	LASER open circuit disabled output.
E-504	LASER current limit disabled output.
E-505	LASER voltage limit disabled output.
E-507	LASER Power limit disabled output.
E-510	LASER out of tolerance disabled output.
E-511	LASER control error disabled output.
E-512	Analog section status is all 1's or all 0's (power down).
E-513	Serial EEPROM checksum error.
E-515	Laser Output must be off to change ranges.
E-516	Incorrect Configuration for Calibration Sequence to start.
E-519	Setting a measurement is only valid during the calibration phase for that measurement. User has tried to calibrate a measurement without first entering the required calibration mode.

Table 3.5 LDX-3200 Series Error Codes

CHAPTER 4 **1**

COMMAND REFERENCE **1**

 INTRODUCTION 1

 LDX-3200 SERIES DEVICE-DEPENDENT COMMANDS 4

 LDX-3200 SERIES DEVICE-DEPENDENT COMMAND REFERENCE 5

CHAPTER 4

COMMAND REFERENCE

INTRODUCTION

This chapter is a guide to all of the device-dependent commands for the LDX-3200 Series Precision Current Source. This chapter is divided into two parts. The first part contains an overview of the remote commands used by the LDX-3200 Series Precision Current Source. The second part contains all of the LDX-3200 Series Precision Current Source commands in alphabetical order. Figure 4.1 shows the format for the device command descriptions in this chapter. The commands which emulate local (front panel) operation are denoted by the solid box next to the Local label in the upper left corner of the command description.

LDX-3200 SERIES DEVICE-DEPENDENT COMMANDS

<u>NAME</u>	<u>PARAMETERS</u>	<u>FUNCTION</u>
DELAY	1	Used to create a delay in the execution of further commands.
ERR?	NONE	Returns errors generated since the last query.
LAS:CALMD	1	Used to set the CAL PD (monitor responsivity) constant.
LAS:CALMD?	NONE	Returns the CAL PD (monitor responsivity) constant.
LAS:CAL:CONST?	1	Factory use only.
LAS:CAL:LDI	NONE	Used to enter the laser current calibration mode.
LAS:CAL:LDI?	NONE	Returns the ready state for entering the laser current calibration value.
LAS:CAL:LDV	NONE	Used to enter the laser voltage calibration mode.
LAS:CAL:LDV?	NONE	Returns the ready state for entering the laser voltage calibration value.
LAS:CAL:MDI	NONE	Used to enter the monitor photodiode current calibration mode.
LAS:CAL:MDI?	NONE	Returns the ready state for entering the monitor PD current calibration value.
LAS:COND?	NONE	Returns the value of the LASER condition register.
LAS:DEC	0, 1 or 2	Used to decrease the laser current set point value by one or more steps.
LAS:DIS	1	Turns the LASER display on or off.
LAS:DIS?	NONE	Returns the LASER display value.
LAS:DIS:LDI	NONE	Turn on/off LASER display to show laser output current.
LAS:DIS:LDI?	NONE	Returns status of laser output current display, on/off.
LAS:DIS:LDV	NONE	Turn on/off LASER display to show laser output voltage.
LAS:DIS:LDV?	NONE	Returns status of laser output voltage display, on/off.
LAS:DIS:MDI	NONE	Turn on/off LASER display to show PD monitor current.
LAS:DIS:MDI?	NONE	Returns status of photo diode monitor current display, on/off.
LAS:DIS:MDP	NONE	Turns on/off LASER display to show PD monitor power.
LAS:DIS:MDP?	NONE	Returns status of photodiode monitor power display, on/off.
LAS:DIS:PARAM	NONE	Enables LASER display to show parameter values.
LAS:DIS:SET	NONE	Shows the LASER display set point corresponding to mode
LAS:DIS:SET?	NONE	Returns status of LASER set point display, on/off.

Table 4.1 LDX-3200 Series Device-Dependent Commands

LDX-3200 SERIES DEVICE-DEPENDENT COMMANDS

<u>NAME</u>	<u>PARAMETERS</u>	<u>FUNCTION</u>
LAS:ENAB:COND	1	Sets the enable register for LASER conditions.
LAS:ENAB:COND?	NONE	Returns the value of the LAS conditions enable register.
LAS:ENAB:EVE	1	Sets the enable register for LAS events.
LAS:ENAB:EVE?	NONE	Returns the value of the LAS event enable register.
LAS:ENAB:OUTOFF	1	Sets the enable register for LAS conditions which turn the LAS output off.
LAS:ENAB:OUTOFF?	NONE	Returns the value of the LAS outoff enable register.
LAS:EVENT?	NONE	Returns the value of the LAS event register.
LAS:LDI	1	Used to set the LASER constant current source set point value.
LAS:LDI?	NONE	Used to return the constant current source measured value
LAS:INC	0, 1 or 2	Used to increment the LASER set point value by one or more steps.
LAS:LDV	1	Used to set the laser voltage value for calibration.
LAS:LDV?	NONE	Used to return the measured laser voltage value
LAS:LIM:I1	1	Used to set the LASER current source limit (high range for LDX-3210).
LAS:LIM:I1?	NONE	Used to return the LASER current source limit (high range for LDX-3210).
LAS:LIM:I2	1	Used to set the LASER current source limit (low range for LDX-3220).
LAS:LIM:I2?	NONE	Used to return the LASER current source limit (low range for LDX-3220).
LAS:LIM:I5	1	Used to set the LASER current source limit (high range for LDX-3220, low range for LDX-3210).
LAS:LIM:I5?	NONE	Used to return the LASER current source limit (high range for LDX-3220, low range for LDX-3210).
LAS:LIM:MDP	1	Used to set the constant optical power (from monitor PD) limit value.
LAS:LIM:MDP?	NONE	Used to return the optical power (from monitor PD) limit value.
LAS:LIM:V	1	Used to set the LASER compliance voltage limit value.
LAS:LIM:V?	NONE	Used to return the LASER compliance voltage limit value.
LAS:MDI	1	Used to set the constant optical power set point, if PD responsivity is 0.
LAS:MDI?	NONE	Used to return the monitor PD current measured value.
LAS:MDLN	1	Used to enable/disable the front panel modulation input.
LAS:MDLN?	NONE	Used to return the status of the front panel modulation input.
LAS:MDP	1	Used to set the constant optical power set point.
LAS:MDP?	NONE	Returns the actual monitor PD power value.
LAS:MODE?	NONE	Returns the mode, I (current), IHBW (high bandwidth) or P (optical power).
LAS:MODE:IHBW	NONE	Sets the mode to constant current, high bandwidth.
LAS:MODE:ILBW	NONE	Sets the mode to constant current (low bandwidth) mode.
LAS:MODE:MDP	NONE	Sets the mode to constant optical power mode.
LAS:OUT	1	Used to enable/disable the current source output.
LAS:OUT?	NONE	Returns the current source output status.
LAS:RAN	1	Sets the laser current output range.
LAS:RAN?	NONE	Returns the laser current output range.
LAS:SET:LDI?	NONE	Returns the laser constant I (current) set point.
LAS:SET:MDI?	NONE	Returns the laser constant optical power set point.

Table 4.1 LDX-3200 Series Device-Dependent Commands (Cont.)

LDX-3200 SERIES DEVICE-DEPENDENT COMMANDS

<u>NAME</u>	<u>PARAMETERS</u>	<u>FUNCTION</u>
LAS:SET:MDP?	NONE	Returns the constant P (optical power) set point
LAS:STEP	1	Used to set the LASER set point step value.
LAS:STEP?	NONE	Returns the LASER set point step value.
LAS:TOL	2	Used to set the LASER set point tolerance value and time period value.
LAS:TOL?	NONE	Used to return the LASER set point tolerance value and time period value.
MES	1	Used to enter a string message of up to 16 bits.
MES?	NONE	Returns a previously stored ASCII message.
RAD	1	Sets the radix type for numerical data. Decimal, binary, octal, or hexadecimal.
RAD?	NONE	Used to return the radix type for numerical data.
SECURE	1	Used to gain access to protected data.
TERM	1	Used to add a carriage return to the device terminator.
TERM?	NONE	Returns the status of the TERM command.
TIME?	NONE	Returns the elapsed time since the instrument was last powered up.
TIMER?	NONE	Returns the elapsed time since the timer was last reset.

Table 4.1 LDX-3200 Series Device-Dependent Commands (Cont.)

LDX-3200 SERIES DEVICE-DEPENDENT COMMANDS

This section contains all of the device-dependent commands for the LDX-3200 Series Precision Current Source, listed in alphabetical order. Sub-sections for each path are presented, listing the commands which are legal for that path. See Figure 3.1 for command path tree structure.

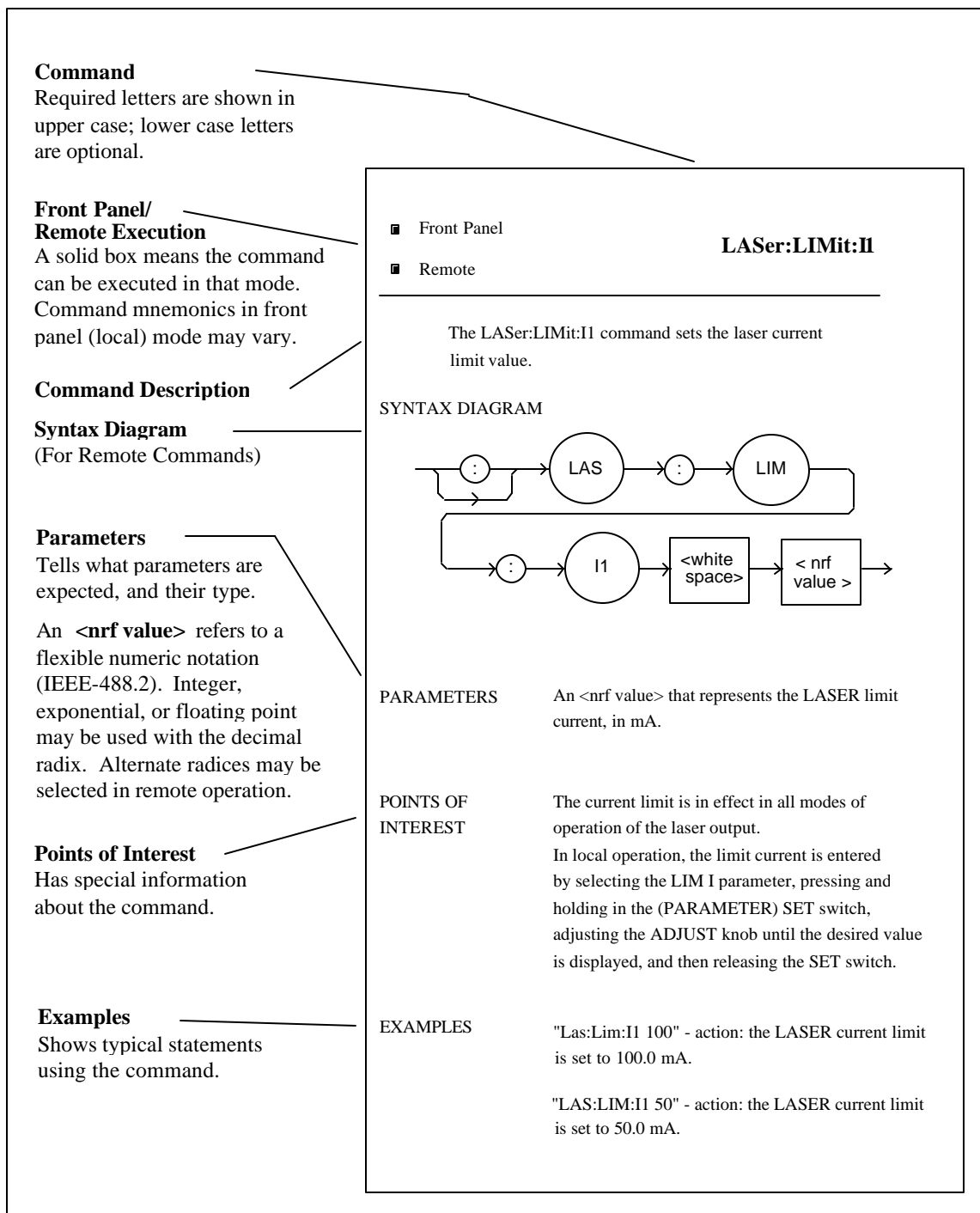

Figure 4.1 Command Description Format

LDX-3200 SERIES DEVICE-DEPENDENT COMMAND REFERENCE

The following pages contain a reference for the device-dependent commands of the LDX-3200 Series Precision Current Source. This reference contains useful information for both local and remote operation of the LDX-3200 Series Precision Current Source.

References to the front panel labels are capitalized in the following reference pages (as is done throughout this manual). Therefore, a reference to the LOCAL switch is meant to signify the actual switch labeled LOCAL on the front panel of the LDX-3200 Series Precision Current Source.

In some references, parentheses are used to signify the labeled area for a particular switch or LED indicator on the front panel. For example, (PARAMETER) SET refers to the switch labeled "SET" in the PARAMETER area of the front panel.

The DELAY command causes the execution of commands to be delayed by a user-defined time. This command is similar to the *WAI common command, except that execution resumes after the specified number of milliseconds, instead of waiting for the Operation-Complete flag to be set.

SYNTAX DIAGRAM

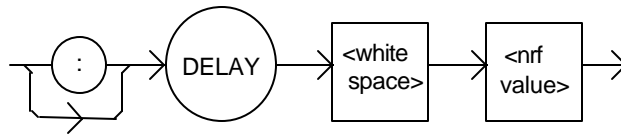

PARAMETERS An <nrf value> which represents the delay time, in milliseconds.

POINTS OF INTEREST The Operation-Complete flag is held false until the delay period elapses, but the *OPC? query will not execute until the delay period has elapsed.

This command is useful for creating delays which don't require a lot of program code and don't tie up the GPIB during execution.

The delay time is approximate, with an error of about $\pm 10\%$.

EXAMPLES "DELAY 500" -action: Further commands and queries are not executed until about 0.5 seconds have elapsed from the time this command is executed.

"LAS:LDI 22;Delay 2000;LAS:LDI?" -actions: The current is set to 22.0 mA, then the LDX-3200 Series Precision Current Source waits for about 2.0 seconds before returning the measured current.

NOTE

Care should be taken to set the GPIB time-out appropriately for use with the Delay command.

The ERRors? query returns a list of command and device errors which have occurred since the last query. These errors are notated by a number which corresponds to the type of error which occurred. See Chapter 3 for information regarding error handling.

SYNTAX DIAGRAM

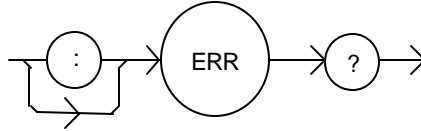

PARAMETERS None.

POINTS OF INTEREST The response data will be a list of the current errors. The errors are represented by numbers and are separated by commas. A response of 0 indicates that no errors were reported. The response data is sent as character data. Up to ten error codes are stored between error queries.

EXAMPLES "ERR?" -response: 0, means no errors reported.

"Errors?" -response: 201, means that the <PROGRAM DATA> (parameter) value out of range error was reported since the last ERR? query.

- Front Panel
- Remote

LASer:CALMD

The LASer:CALMD command sets the laser's photodiode feedback responsivity (the CAL PD parameter).

SYNTAX DIAGRAM

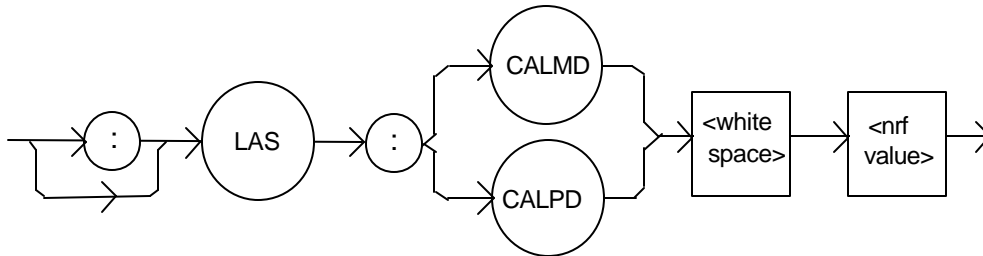

PARAMETERS An <nrf value>, in microamps/milliwatt. The range is 0 to 1000.

POINTS OF INTEREST If the parameter is set to 0, the LDX-3200 Series Precision Current Source will operate in a constant I_{PD} mode, when Constant P (MDP) mode is selected.

The parameter should be set to 0 for I_{PD} operation modes. Otherwise, the value of this parameter is used to convert between I_{PD} and P_{PD} values. The units of this parameter are microamps/milliwatt.

EXAMPLES "LAS:CALMD 0" -action: sets the CAL PD parameter to 0. This enables the constant I_{PD} mode of operation.

"Laser:Calmd 1" -action: sets the CAL PD parameter to 1.00 microamp/milliwatt. Therefore, a photodiode feedback current of 1 microamp will cause the P_{PD} display to read 1 milliwatt.

- Front Panel
- Remote

LASer:CALMD?

The LASer:CALMD? query returns the value of the laser's photodiode feedback responsivity (CAL PD parameter) setting.

SYNTAX DIAGRAM

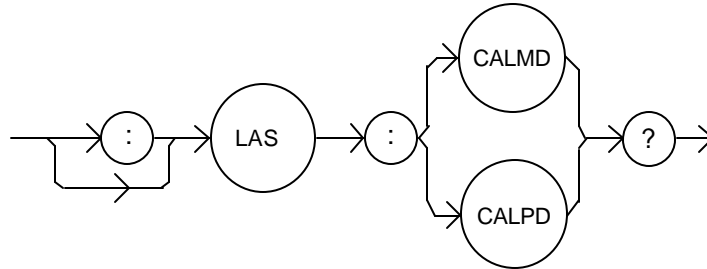

POINTS OF INTEREST

If this value is 0, the LDX-3200 Series Precision Current Source will be set to operate in constant I_{PD} mode, and the I_{PD} set point value will be in effect. If this value is non-zero, the LDX-3200 Series Precision Current Source will be set to operate in constant P_{PD} mode, and the P_{PD} set point value will be in effect.

If this value is 0, the front panel P_{PD} will display "-.-", and no P_{PD} value can be calculated.

EXAMPLES

"LASER:CALMD?" -response: 0, means the LDX-3200 Series Precision Current Source is set for operation in constant I_{PD} mode (if P mode is also selected).

"Las:Calmd?" -response: 1.1, means the LDX-3200 Series Precision Current Source is set for operation in constant P_{PD} mode (if P mode is also selected) and the responsivity is set to 1.1 $\mu\text{A}/\text{mW}$. 1.1 μA of photodiode feedback current represents 1 mW of optical power.

- Front Panel
- Remote

LAS:CAL:CONST?

The LAS:CAL:CONST? query returns a stored calibration value. It is intended for factory use only.

- Front Panel
- Remote

LASer:CAL:LDI

The LASer:CAL:LDI command is used to enter the LASER current set point, measurement, and limit (in low bandwidth mode) calibration mode.

SYNTAX DIAGRAM

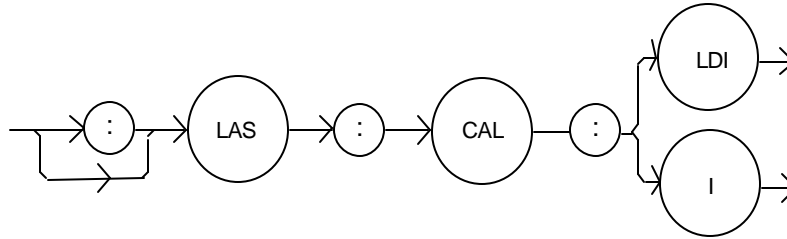

PARAMETERS None.

POINTS OF INTEREST

Since the limit circuit is the same for both high and low bandwidth modes, it is only calibrated when low bandwidth mode is selected.

After this command is issued, the LDX-3200 Series Precision Current Source will allow calibration of the current set point, measurement, and limit (if low bandwidth mode is selected). This procedure is outlined in Chapter 6.

The calibration defaults to the selected bandwidth setting. Therefore, it is necessary to select the desired bandwidth (I or I_{HBW}), and turn the LASER output on before performing the calibration for that bandwidth.

Calibration is performed at the current set point, wherever it is set. If the LASER output is not on, E 516 is displayed.

In remote operation, the LASer:CAL:LDI? query may be used to determine if the LDX-3200 Series Precision Current Source is ready for the user to enter a value.

EXAMPLES

"Las:CAL:LdI" -action: the LDX-3200 Series Precision Current Source enters calibration mode for LASER current.

"Las:Cal:LDI" -action: the LDX-3200 Series Precision Current Source enters calibration mode for LASER current.

■ Front Panel

LASer:CAL:LDI?

■ Remote

The LASer:CAL:LDI? query is used to determine that the LDX-3200 Series Precision Current Source is ready for a value to be entered during the calibration cycle of the LASer:CAL:LDI mode.

SYNTAX DIAGRAM

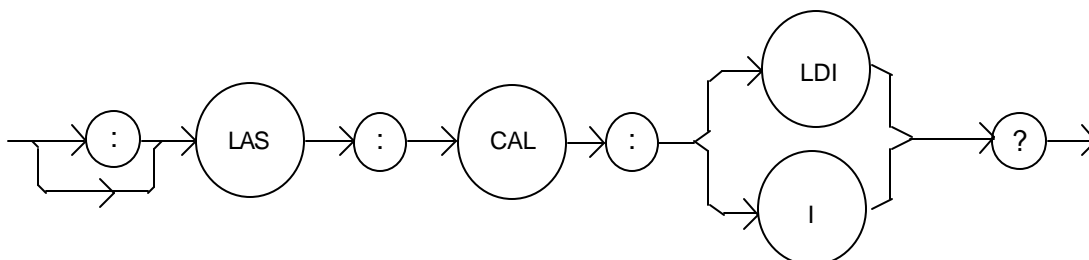

POINTS OF INTEREST

After this query is issued and a response of 1 is received, the LDX-3200 Series Precision Current Source will be ready for the user to enter a current value via the LASer:LDI command (see Chapter 6).

EXAMPLES

"LASer:CAL:LDI?" -response: 1, means the LDX-3200 Series Precision Current Source is ready for the user to enter a current value via the LASer:LDI command.

"LASer:Cal:LdI?" -response: 0, means the LDX-3200 Series Precision Current Source is not yet ready for the user to enter a LASER current value.

- Front Panel
- Remote

LASer:CAL:LDV

The LASer:CAL:LDV command is used to enter the LASER voltage measurement calibration mode.

SYNTAX DIAGRAM

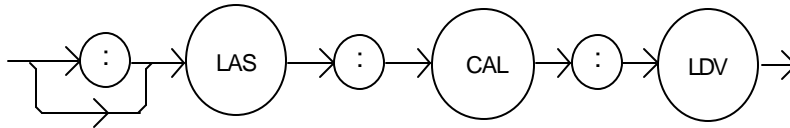

PARAMETERS

None.

POINTS OF INTEREST

After this command is issued, the LDX-3200 Series Precision Current Source will allow calibration of the laser voltage measurement. This procedure is outlined in Chapter 6.

The LASer:CAL:LDV? query may be used to determine if the LDX-3200 Series Precision Current Source is ready for the user to enter a value.

EXAMPLES

"Las:CAL:Ldv" -action: the LDX-3200 Series Precision Current Source enters calibration mode for LASER voltage.

"Las:Cal:LDV" -action: the LDX-3200 Series Precision Current Source enters calibration mode for LASER voltage.

- Front Panel
- Remote

LASer:CAL:LDV?

The LASer:CAL:LDV? query is used to determine that the LDX-3200 Series Precision Current Source is ready for a value to be entered during the calibration cycle of the LASer:CAL:LDV mode.

SYNTAX DIAGRAM

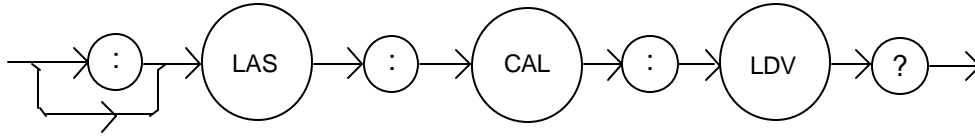

POINTS OF INTEREST

After this query is issued and a response of 1 is received, the LDX-3200 Series Precision Current Source will be ready for the user to enter a voltage value via the LASer:LDV command (see Chapter 6).

EXAMPLES

"LASer:CAL:LDV?" -response: 1, means the LDX-3200 Series Precision Current Source is ready for the user to enter a voltage value via the LASer:LDV command.

"LASer:Cal:LdV?" -response: 0, means the LDX-3200 Series Precision Current Source is not yet ready for the user to enter a LASER voltage value.

- Front Panel
- Remote

LASer:CAL:MDI

The LASer:CAL:MDI command is used to enter the LASER photodiode current calibration mode.

SYNTAX DIAGRAM

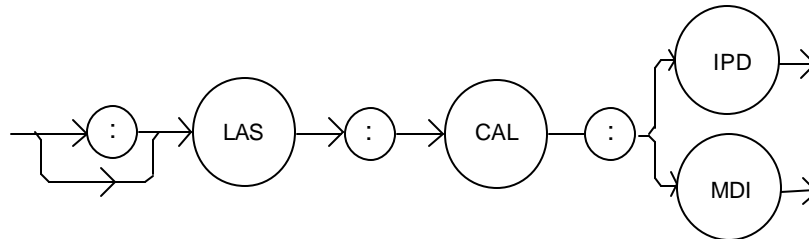

PARAMETERS None.

POINTS OF INTEREST

After this command is issued, the LDX-3200 Series Precision Current Source will automatically enter the LASER photodiode current calibration mode. When the LDX-3200 Series Precision Current Source is ready, the user should enter the true measured value. This procedure is outlined in Chapter 6.

If the LASER output is not ON, or if the P mode is not selected, error code E516 will be generated.

In remote operation, the LASer:CAL:MDI? query may be used to determine if the LDX-3200 Series Precision Current Source is ready for the user to enter a value via the LASer:MDI command.

EXAMPLES

"Las:CAL:MDI" -action: the LDX-3200 Series Precision Current Source enters the LASER photodiode current calibration mode.

"LAS:Cal:MDI" -action: the LDX-3200 Series Precision Current Source enters the LASER photodiode current calibration mode.

- Front Panel
- Remote

LASer:CAL:MDI?

The LASer:CAL:MDI? query is used to determine that the LDX-3200 Series Precision Current Source is ready for a value to be entered during the calibration cycle of the LASer:CAL:MDI mode.

SYNTAX DIAGRAM

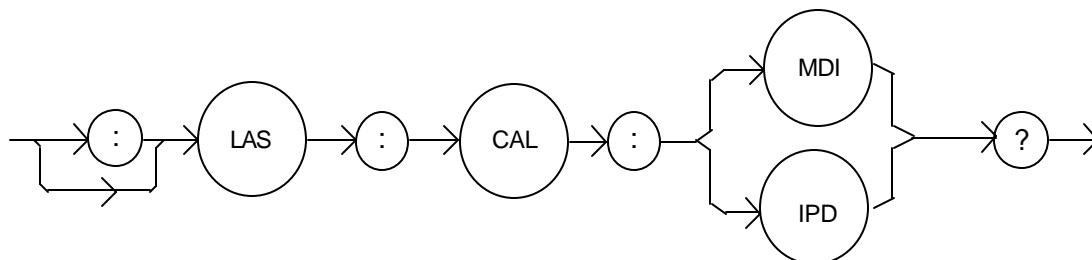

POINTS OF INTEREST

After this query is issued and a response of 1 is received, the LDX-3200 Series Precision Current Source be ready for the user to enter a photodiode current value via the LASer:MDI command (see Chapter 6).

EXAMPLES

"LAS:CAL:MDI?" -response: 1, means the LDX-3200 Series Precision Current Source is ready for the user to enter a photodiode current value via the LASer:MDI command.

The LASer:COND? query returns the value of the status condition register of the LASER operations.

SYNTAX DIAGRAM

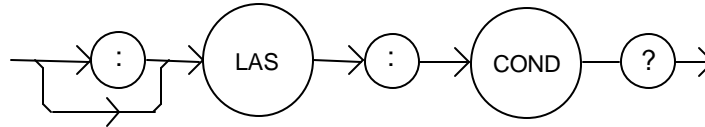

-where the response is the sum of the following:

1 - LASER Current Limit	256 - Output is shorted
2 - LASER Voltage Limit	512 - Output is outside tolerance limit
4 - N/A	1024 - Output on/off state
8 - Power limit	2048 - Ready for calibration data state
16 - Interlock disabled	4096 - N/A
32 - N/A	8192 - N/A
64 - Compliance Voltage Limit	16384 - N/A
128 - Open circuit	32768 - N/A

POINTS OF INTEREST

The LASER conditions which are reported to the status byte are set via the LASer:ENABLE:COND command.

The Open circuit condition is only present while the LASER output is on, and when the hardware detects this condition, it will turn the LASER output off. Therefore, the Open Circuit condition is fleeting and may be missed via the LAS:COND? query. Therefore, the user should test for the Open Circuit Event via the LAS:EVENT? query.

The LASER condition status is constantly changing, while the event status is only cleared when the event status is read or the *CLS command is issued.

EXAMPLES

"LAS:COND?" -response: 513, means that the LASER limit current and out of tolerance LASER conditions currently exist.

"Radix Hex; Laser:Cond?" -response: #H108, means that the LASER Output shorted (output is off) and Power limit conditions currently exist.

The LASer:DEC command decrements the selected laser control mode set point by one or more steps. Optional parameters allow multiple steps to be decremented and the time (in milliseconds) between decrements to be set, respectively. This is an overlapped command. Other commands may be executed while this function is in progress.

SYNTAX DIAGRAM

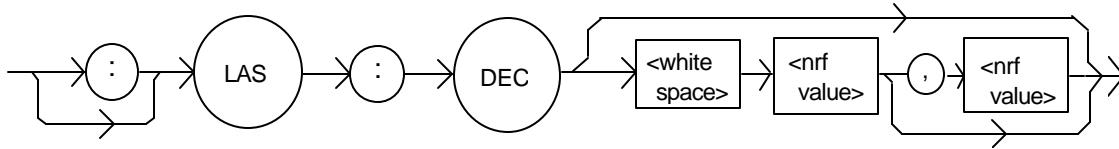

PARAMETERS 0, 1, or 2. The first optional parameter is the number of steps, and the second optional parameter is the number of milliseconds between steps.

POINTS OF INTEREST The decremental default amount is one step. The step size can be edited via the LAS:STEP command. LDX-3210 default values are 0.001/0.002 mA (50/100 mA range), 0.01 mW, or 1 μ A (if CALMD = 0), depending on the mode of operation. LDX-3220 default values are 0.01 mA, 0.01 mW, or 1 μ A.

If the first optional parameter is used, but not the second, the user may decrement the LASER set point by a multiple of the LAS:STEP size, without changing the LAS:STEP size.

If the both optional parameters are used, the user may create an automated stepping ramp function for the LASER output.

If the first optional parameter is entered as zero, "LAS:DEC 0", the command will do nothing.

The minimum time to complete one decrement is about 20 msec. Therefore, values for the second optional parameter (time between decrements) have a practical minimum of 20.

This command should not be overlapped with "LAS:INC" or other "LAS:DEC" commands.

EXAMPLES "LAS:MODE:I; LAS:STEP 3; LAS:DEC" -action: The laser source current set point is decremented by 0.03 mA (LDX-3220), or 0.003 mA (LDX-3210 on 50 mA range), or 0.006 mA (LDX-3210 on 100 mA range).

"LAS:MODE:I; LAS:STEP 3; LAS:DEC 3" -action: The laser source current set point is decremented by three times the amount described in the first example.

"LAS:MODE:I; LAS:STEP 3; LAS:DEC 3,5000" -action: The laser source current set point is decremented by the amount described in the first example, three times, with 5 seconds between decremental steps.

The LASer:DISplay command enables or disables (turns off) the display and some LEDs.

SYNTAX DIAGRAM

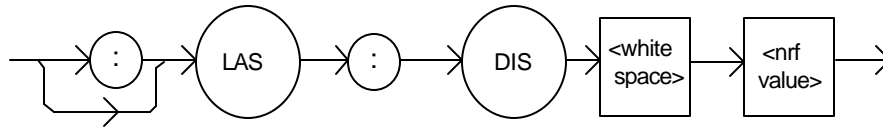

PARAMETERS An <nrf value> -where 1 = on, 0 = off.

POINTS OF INTEREST Turning the display and LEDs off means that a message of all blank spaces is sent to the display, and most of the LEDs will be turned off.

EXAMPLES "las:dis 1" -action: turns the display on and enables the LEDs.

"Laser:dis Off" -action: turns the display off and disables most of the LEDs.

The LASer:DISplay? query returns the value shown on the display.

SYNTAX DIAGRAM

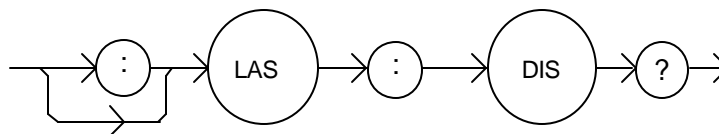

-where the response is character data in quotes.

POINTS OF INTEREST Returns the actual (6-character) string from the output buffer to the display. If the display is disabled, it returns " .".

EXAMPLES "LAS:DIS?" -response: "- 99.9", means the display shows "- 99.9".

"Laser:DISp?" -response: " 0.6", means the display shows " 0.6".

- Front Panel
- Remote

LASer:DISplay:LDI

The LASer:DISplay:LDI command sets the display to show the LDI (laser diode current) measurement.

SYNTAX DIAGRAM

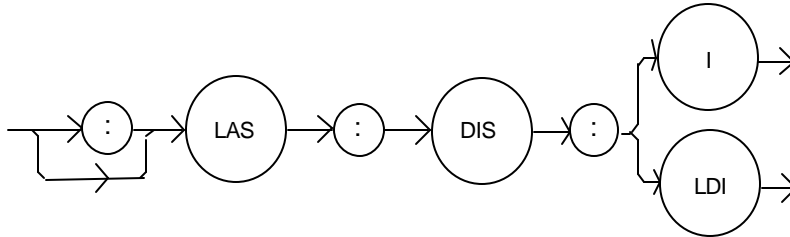

PARAMETERS None.

POINTS OF INTEREST The LDI measurement display mode is turned off automatically when another display selection is enabled.

EXAMPLES "LAS:DIS:LDI" -action: enables the display for current values.

- Front Panel
- Remote

LASer:DISplay:LDI?

The LASer:DISplay:LDI? query returns the status of the LDI measurement display mode.

SYNTAX DIAGRAM

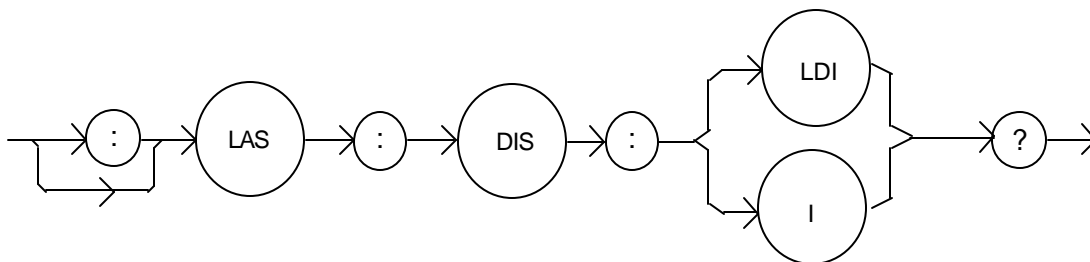

-where the response is 0 or 1.

POINTS OF INTEREST In local operation, the status of the LDI measurement display mode is indicated by the enunciator next to the display (mA will be illuminated and not blinking when the display is in LDI measurement mode).

EXAMPLES "LAS:DIS:LDI?" -response: 0, means that the LDI measurement is not displayed.

"Las:dis:ldI?" -response: 1, means that the LDI measurement is displayed.

■ Front Panel

LASer:DISplay:LDV

■ Remote

The LASer:DISplay:LDV command sets the display to show the laser forward voltage measurement.

SYNTAX DIAGRAM

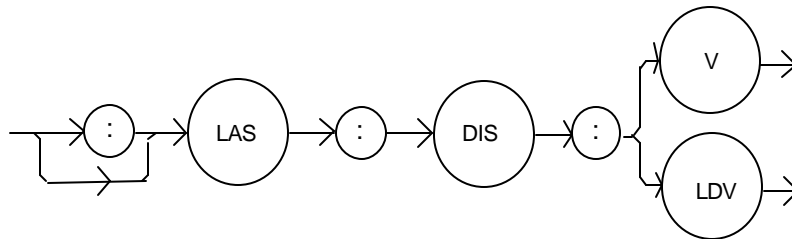

PARAMETERS None.

POINTS OF INTEREST

The LDV measurement mode is turned off automatically when another display selection is enabled.

EXAMPLES "LAS:DIS:LDV" -action: enables the display for LDV measurement mode.

□ Front Panel

LASer:DISplay:LDV?

■ Remote

The LASer:DISplay:LDV? query returns the status of LDV (laser diode voltage) measurement display mode.

SYNTAX DIAGRAM

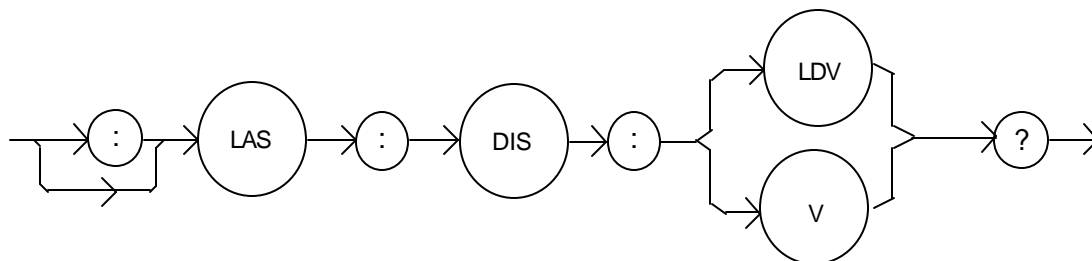

-where the response is 0 or 1.

POINTS OF INTEREST

In local operation, the status of the LDV measurement mode is indicated by the enunciator next to the display (V will be illuminated when the display is in LDV measurement mode).

EXAMPLES "LAS:DIS:LDV?" -response: 0, means that the laser voltage measurement is not displayed.

"LAS:DIS:LDV?" -response: 1, means that the laser voltage measurement is displayed.

■ Front Panel

LASer:DISplay:MDI

■ Remote

The LASer:DISplay:MDI command sets the display to show the monitor photodiode current measurement.

SYNTAX DIAGRAM

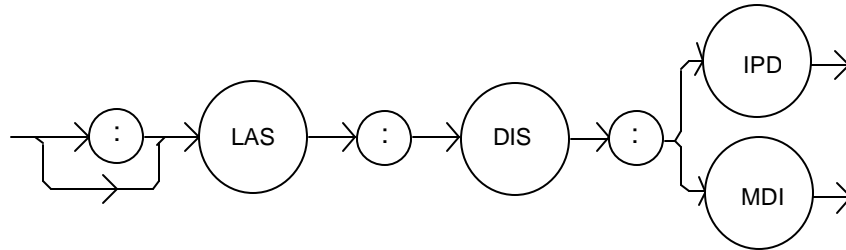

PARAMETERS None.

POINTS OF INTEREST

The MDI measurement display is turned off automatically when another display selection is enabled.

EXAMPLES "LAS:DIS:MDI" -action: enables the display for photodiode current measurement values.

Laser:Disp:Mdi" -action: enables the display for photodiode current measurement values.

□ Front Panel

LASer:DISplay:MDI?

■ Remote

The LASer:DISplay:MDI? query returns the status of the MDI measurement display mode.

SYNTAX DIAGRAM

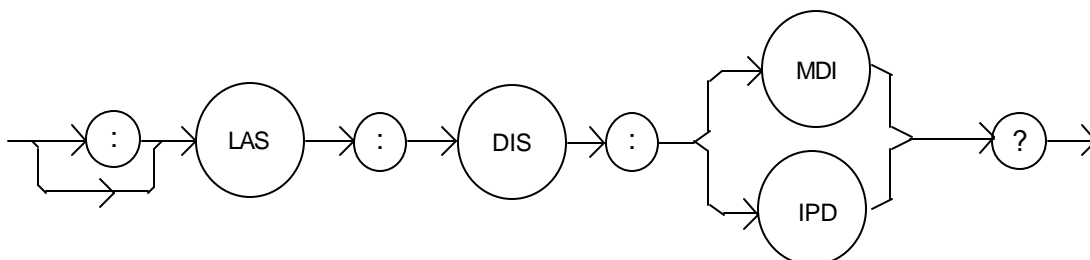

-where the response is 0 or 1.

POINTS OF INTEREST

In local operation, the status of the MDI measurement mode is indicated by the enunciator next to the display (μA will be illuminated and not blinking when the display is in MDI measurement mode).

EXAMPLES

"LAS:DIS:MDI?" -response: 0, means that the laser photodiode monitor current measurement is not displayed.

"Las:dis:MDI?" -response: 1, means that the monitor PD current measurement is displayed.

- Front Panel
- Remote

LASer:DISplay:MDP

The LASer:DISplay:MDP command sets the display to show the monitor photodiode power measurement.

SYNTAX DIAGRAM

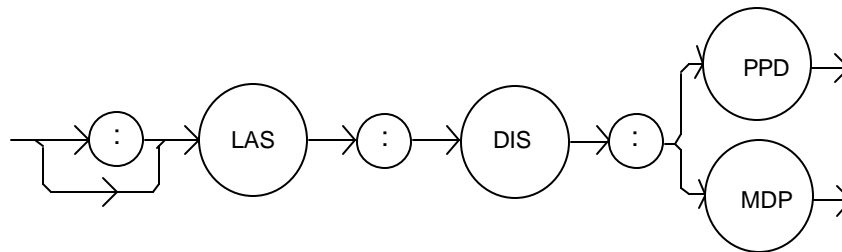

PARAMETERS

None.

POINTS OF INTEREST

The MDP measurement display is turned off automatically when another display selection is enabled.

EXAMPLES

"Las:Display:MDp" -action: enables the display for photodiode power measurement values.

"Laser:Disp:MDP" -action: enables the display for photodiode power measurement values.

- Front Panel
- Remote

LASer:DISplay:MDP?

The LASer:DISplay:MDP? query returns the status of the MDP (monitor diode power) measurement display mode.

SYNTAX DIAGRAM

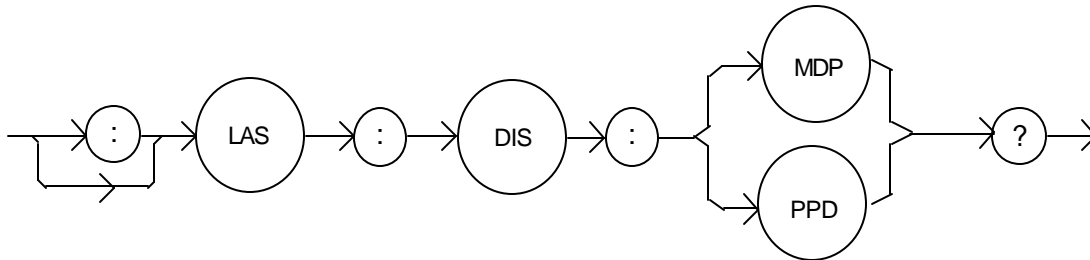

-where the response is 0 or 1.

POINTS OF INTEREST

In local operation, the status of the MDP measurement mode is indicated by the enunciator next to the display (mW will be illuminated and not blinking when the display is in MDP measurement mode).

EXAMPLES

"LAS:DISp:MDp?" -response: 0, means that the MDP measurement is not displayed.

"Las:dis:MDP?" -response: 1, means that the MDP measurement is displayed.

- Front Panel
- Remote

LASer:DISplay:PARAM

The LASer:DISplay:PARAM command enables the display to show the parameter values.

SYNTAX DIAGRAM

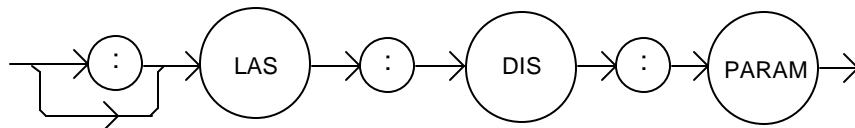

PARAMETERS

None.

POINTS OF INTEREST

This command has the same effect as pressing the (PARAMETER) **SELECT** switch while in LASER mode. The selected parameter will be displayed for three seconds. The actual LASER PARAM display is turned off automatically when a display selection is enabled.

Each time the command is issued, the next LASER parameter will be selected, see Chapter 2 for more information.

EXAMPLES "Laser:Display:Param" -action: selects a parameter and displays its value.

"LAS:DIS:PARAM" -action: selects a parameter and displays its value.

■ Front Panel

LASer:DISplay:SET

■ Remote

The LASer:DISplay:SET command sets the display to show the set point of the selected display mode.

SYNTAX DIAGRAM

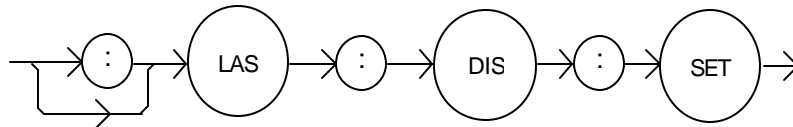

PARAMETERS None.

POINTS OF INTEREST

Using this command has the same effect as physically holding the (DISPLAY) **SELECT** switch down continuously.

EXAMPLES

"Las:Dis:Set" -action: enables the display for the set point of the selected mode: LDI, MDI (I_{PD}) or MDP (P_{PD})

"LAS:Dis:Set" -action: enables the display for the set point of the selected display mode.

□ Front Panel

LASer:DISplay:SET?

■ Remote

The LASer:DISplay:SET? query returns the status of the set point display mode.

SYNTAX DIAGRAM

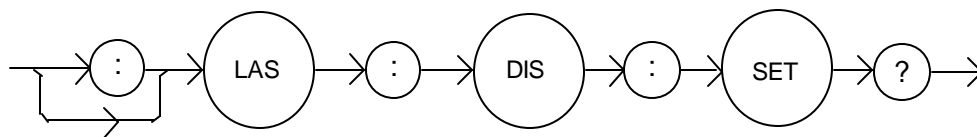

-where the response is 0 or 1.

POINTS OF INTEREST

The set point display will not time out when REMOTE operation is used. (It will be continuously displayed.)

EXAMPLES

"LAS:DISPLAY:SET?" -response: 0, means the set point is not shown on the display.

"Las:Dis:Set?" -response: 1, means the set point value is shown on the display.

- Front Panel
- Remote

LASer:ENABle:COND

The LASer:ENABle:COND command sets the condition status enable register of the LASER operations for summary (in bit 3 of the status byte) and generation of service requests.

SYNTAX DIAGRAM

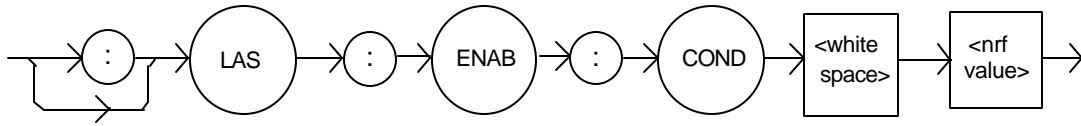

PARAMETERS An <nrf value> whose sum represents the enabled bits:

1 - LASER Current Limit	256 - Output is Shorted
2 - LASER Voltage Limit	512 - Output is Outside Tolerance Limit
4 - N/A	1024 - Output On/Off State
8 - Power Limit	2048 - Ready for Calibration Data State
16 - Interlock Disabled	4096 - N/A
32 - N/A	8192 - N/A
64 - Compliance Voltage Limit	16384 - N/A
128 - Open Circuit	32768 - N/A

POINTS OF INTEREST

The enabled or disabled LASER conditions can be read by using the LASer:ENABle:COND? query.

The LASER condition status can be monitored by the LASer:COND? query. If any of the enabled LASER conditions are true, bit 3 of the status byte register will be set.

The enable registers normally retain their values at power-up (as they were at power-down) unless the power-on status clear flag is set true (for more information see the *PSC definition, in the IEEE488.2 specification).

EXAMPLES

"LAS:ENAB:COND 129" -action: enables the LASER status condition register so that the Open circuit and LASER current limit conditions will be summarized in the status byte (bit 3).

Laser:Enable:Cond #H0FDB" - action: enables the LASER status condition register so that any and all of the above conditions will be reported in the status byte register (bit 3).

- Front Panel
- Remote

LASer:ENABLE:COND?

The LASer:ENABLE:COND? query returns the value of the status condition enable register of the LASER operations.

SYNTAX DIAGRAM

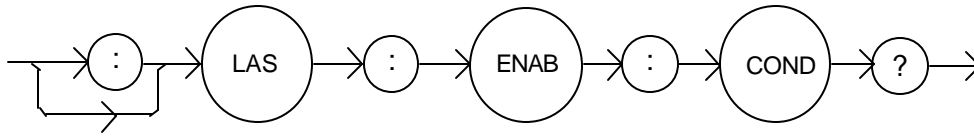

-where the response is the sum of the following:

1 - LASER Current Limit	256 - Output is Shorted
2 - LASER Voltage Limit	512 - Output Changed to be In/Out of Tolerance
4 - N/A	1024 - Output On/Off State
8 - Power Limit	2048 - Ready for Calibration Data State
16 - Interlock Disabled	4096 - N/A
32 - N/A	8192 - N/A
64 - Compliance Voltage Limit	16384 - N/A
128 - Open Circuit	32768 - N/A

POINTS OF INTEREST

The enabled LASER conditions can be set by using the LASer:ENABLE:COND command.

The LASER condition status can be monitored by the LASer:COND? query.

EXAMPLES

"LAS:ENAB:COND?" -response: 17, means that the Laser Current Limit and Interlock disabled LASER conditions will be reported (in summarized form) to the status byte (bit 3).

"Radix Hex; Laser:Enable:Cond?" -response: #H0F9B, means that all of the above conditions will be reported (in summarized form) to the status byte (bit 3).

- Front Panel
- Remote

LASer:ENABle:EVEnt

The LASer:ENABle:EVEnt command sets the status event enable register of the LASER operations. These events are summarized in bit 2 of the status byte register.

SYNTAX DIAGRAM

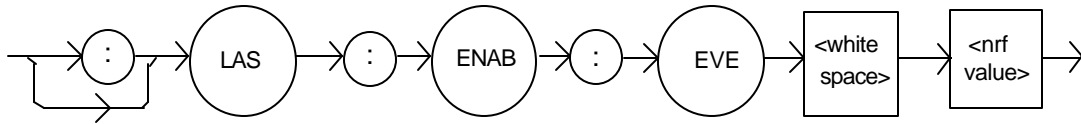

PARAMETERS An <nrf value> whose sum represents the bits which are enabled:

1 - LASER Current Limit	256 - Output is Shorted
2 - LASER Voltage Limit	512 - Output Changed to be In/Out of Tolerance
4 - N/A	1024 - Output On/Off State Changed
8 - Power Limit	2048 - New Measurements Taken
16 - Interlock Changed State	4096 - N/A
32 - N/A	8192 - N/A
64 - Compliance Voltage Limit	16384 - N/A
128 - Open Circuit	32768 - N/A

POINTS OF INTEREST

The enabled LASER events can be read by using the LASer:ENABle:EVEnt? query. The LASER event status can be monitored by the LASer:EVEnt? query.

The enable registers normally retain their values at power-up (as they were at power-down) unless the power-on status clear flag is set true (for more information see the *PSC definition, in the IEEE488.2 specification).

EXAMPLES

"LAS:ENAB:EVENT 136" -action: enables the LASER status event register so that the Open circuit and Power limit events will be reported (in summarized form) to the status byte (bit 2).

"Laser:Enable:Event #H0FDB" -action: enables the LASER status event register so all of the above events will be reported (in summarized form) to the status byte (bit 2).

- Front Panel
- Remote

LASer:ENABLE:EVENT?

The LASer:ENABLE:EVENT? query returns the value of the status event enable register of the LASER operations.

SYNTAX DIAGRAM

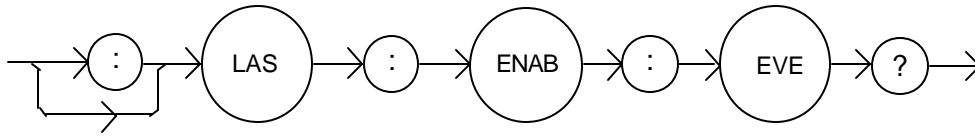

-where the response is the sum of the following:

1 - LASER Current Limit	256 - Output is Shorted
2 - LASER Voltage Limit	512 - Output Changed to be In/Out of Tolerance
4 - N/A	1024 - Output On/Off State
8 - Power Limit	2048 - New Measurements Taken
16 - Interlock State Changed	4096 - N/A
32 - N/A	8192 - N/A
64 - Compliance Voltage Limit	16384 - N/A
128 - Open Circuit	32768 - N/A

POINTS OF INTEREST

The enabled LASER events can be set by using the LASer:ENABLE:EVENT command. The LASER event status can be monitored by the LASer:EVENT? query.

EXAMPLES

"LAS:ENAB:EVE?" -response: 1040, means that the Output on/off state change and Interlock changed LASER events will be reported (in summarized form) to the status byte register (bit 2).

"Radix Hex; Las:Enab:Eve?" -response: #HFDB, means that all of the above events will be reported (in summarized form) to the status byte register (bit 2).

- Front Panel
- Remote

LASer:ENABLE:OUTOFF

The LASer:ENABLE:OUTOFF command sets the status outoff enable register of the LASER operations (things which will turn the LASER output off).

SYNTAX DIAGRAM

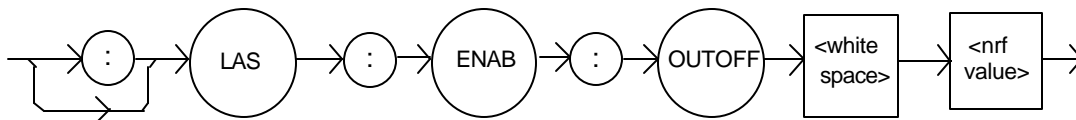

PARAMETERS An <nrf value> whose sum represents the enabled bits:

1 - LASER Current Limit	256 - N/A
2 - LASER Voltage Limit	512 - Output is Out of Tolerance *
4 - N/A	1024 - N/A
8 - Power Limit (With Output On)	2048 - N/A
16 - N/A	4096 - N/A
32 - N/A	8192 - N/A
64 - N/A	16384 - N/A
128 - N/A	32768 - N/A

POINTS OF INTEREST The enabled LASER outoff bits can be read by using the LASer:ENABLE:OUTOFF? query.

The enable registers normally retain their values at power-up (as they were at power-down) unless the power-on status clear flag is set true (for more information see the *PSC definition, in the IEEE488.2 specification).

The factory default value for this register is #B0000100000001000, or #H808, or 2056 decimal.

EXAMPLES "LAS:ENAB:OUTOFF 9" -action: enables the LASER status outoff register so that Power limit and LASER current limit conditions will cause the LASER output to be turned off.

"Las:Enab:Outoff #HE0B" -action: enables the LASER status outoff register so that any or all of the above conditions will cause the LASER output to be turned off.

- Front Panel
- Remote

LASer:ENABLE:OUTOFF?

The LASer:ENABLE:OUTOFF? query returns the value of the status outoff enable register of the LASER operations.

SYNTAX DIAGRAM

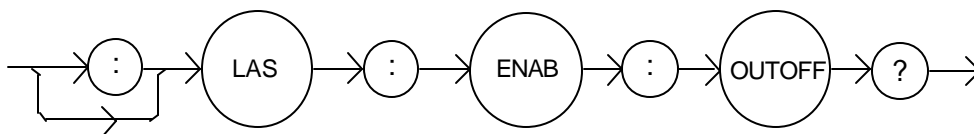

* Warning: If this bit is enabled with the output off, the output may never turn on.

-where the response is the sum of the following:

1 - LASER Current Limit	256 - N/A
2 - LASER Voltage Limit	512 - Output is Out of Tolerance
4 - N/A	1024 - N/A
8 - Power Limit (With Output On)	2048 - N/A
16 - N/A	4096 - N/A
32 - N/A	8192 - N/A
64 - N/A	16384 - N/A
128 - N/A	32768 - N/A

POINTS OF INTEREST

The enabled LASER events can be set by using the LASer:ENABLE:OUTOFF command. The LASER output status can be monitored by the LASer:EVEnt? query.

EXAMPLES

"LAS:ENAB:OUTOFF?" -response: 1, means that the Current Limit Condition will cause the LASER output to be turned off.

"Radix Hex; Las:Enab:Eve?" -response: #H20B, means that all of the above conditions will cause the LASER output to be turned off.

- Front Panel
- Remote

LASer:EVEnt?

The LASer:EVEnt? query returns the value of the status event register of the LASER operations.

SYNTAX DIAGRAM

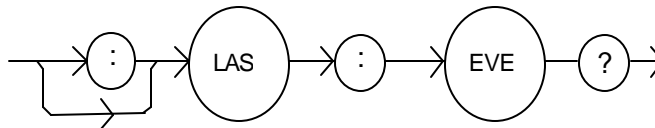

-where the response is the sum of the following:

1 - LASER Current Limit	256 - Output is Shorted
2 - LASER Voltage Limit	512 - Output Changed to be In/Out of Tolerance
4 - N/A	1024 - Output On/Off State Changed
8 - Power Limit	2048 - Measurement Ready
16 - Interlock Disabled	4096 - N/A
32 - N/A	8192 - N/A
64 - Compliance Voltage Limit	16384 - N/A
128 - Open Circuit	32768 - N/A

POINTS OF INTEREST

The LASER conditions that are reported in the status byte can be set by using the LASer:ENABLE:EVENT command.

The LASER event status is only cleared when the event status is read or by the *CLS command, while the condition status is constantly changing.

EXAMPLES

"LAS:EVE?" -response: 513, means that the LASER output tolerance changed and current limit events have occurred since the last LASer:EVENT? query.

"Radix Hex; Laser:Event?" -response: #H88, means that the LASER Power limit and Open circuit events have occurred since the last LASer:EVENT? query.

- Front Panel
- Remote

LASer:INC

The LASer:INC command increments the selected laser control mode set point by one or more steps. Optional parameters allow multiple steps to be incremented and the time (in milliseconds) between increments to be set, respectively. This is an overlapped command. Other commands may be executed while this function is in progress.

SYNTAX DIAGRAM

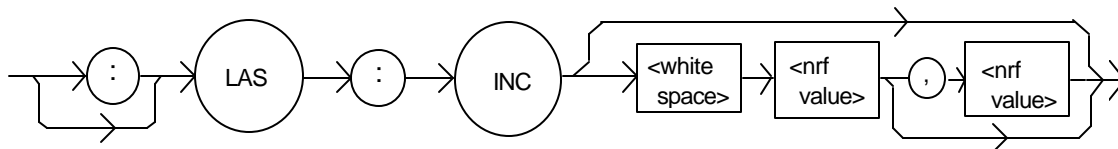

PARAMETERS

0, 1, or 2. The first optional parameter is the number of steps, and the second optional parameter is the number of milliseconds between steps.

POINTS OF INTEREST

The decremental default amount is one step. The step size can be edited via the LAS:STEP command. LDX-3210 default values are 0.001/0.002 mA (50/100 mA range), 0.01 mW, or 1 μ A (if CALMD = 0), depending on the mode of operation. LDX-3220 default values are 0.01 mA, 0.01 mW, or 1 μ A.

If the first optional parameter is used, but not the second, the LASER set point is incremented by a multiple of the LAS:STEP size, without changing the LAS:STEP size. The second optional parameter is the time, in msec, between steps.

If both optional parameters are used, the user may create an automated stepping ramp function for the LASER output.

If the first optional parameter is entered as zero, "LAS:INC 0", the command will do nothing.

The minimum time to complete one increment is about 20 msec. Therefore, values for the second optional parameter (time between increments) have a practical minimum of 20.

This command should not be overlapped with "LAS:DEC" or other "LAS:INC" commands.

EXAMPLES "LAS:MODE:I; LAS:STEP 3; LAS:INC" -action: The laser source current set point is incremented by 0.03 mA (LDX-3220), or 0.003 mA (LDX-3210 on 50 mA range), or 0.006 mA (LDX-3210 on 100 mA range).

"LAS:MODE:I; LAS:STEP 3; LAS:INC 3" -action: The laser source current set point is incremented by three times the amount described in the first example.

"LAS:MODE:I; LAS:STEP 3; LAS:INC 3,5000" -action: The laser source current set point is incremented by the amount described in the first example, three times, with 5 seconds between incremental steps.

"LAS:STEP 1; LAS:Mode:P; Las:INC" -action: The power set point is incremented by 0.01 mW (LDX-3220 or LDX-3210).

- Front Panel
- Remote

LASer:LDI

The LASer:LDI command sets the laser control current.

SYNTAX DIAGRAM

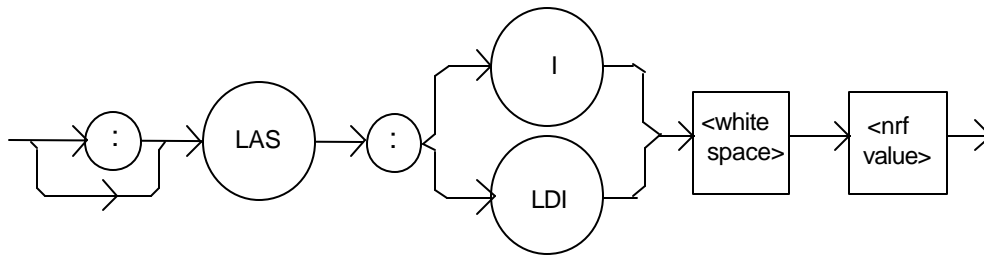

PARAMETERS An <nrf value> which represents the (laser) output current, in mA.

POINTS OF INTEREST Set point is the same for both low and high bandwidth output modes.

EXAMPLES "Las:LDI 400" -action: sets the laser output current to 400.00 mA.

"LAS:ldi 100" -action: sets the laser output current to 100.00 mA.

- Front Panel
- Remote

LASer:LDI?

The LASer:LDI? query returns the value of the measured laser current.

SYNTAX DIAGRAM

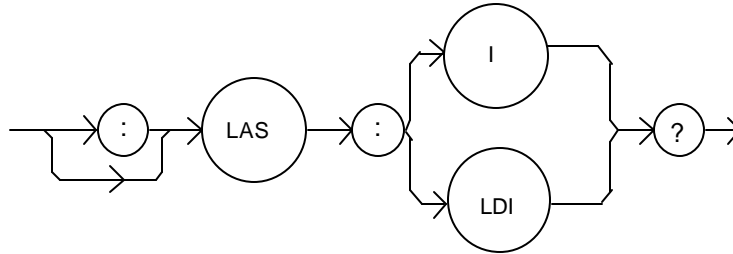

-where the response is the most recent laser current measurement.

POINTS OF INTEREST

Response is the measured laser output current, for either low or high bandwidth modes.

This measurement is updated approximately once every 600 msec.

EXAMPLES

"LAS:ldi?" -response: 30.0, means the measured laser output current is 30.0 mA.

"Laser:LDI?" -response: 100.0, means the measured laser output current is 100.0 mA.

- Front Panel
- Remote

LASer:LDV

The LASer:LDV command sets the laser voltage for calibration of the laser voltage measurement.

SYNTAX DIAGRAM

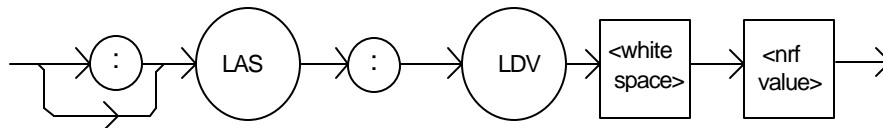

PARAMETERS An <nrf value> which represents the (laser) output voltage, in volts.

POINTS OF INTEREST

Set point is the same for both low and high bandwidth output modes and is entered only for LDV calibration.

EXAMPLES

"Las:LDV 4" -action: enters a value of 4.000 volts.

"LAS:ldv 1.025" -action: enters a value of 1.025 volts.

- Front Panel
- Remote

LASer:LDV?

The LASer:LDV? query returns the value of the measured laser voltage.

SYNTAX DIAGRAM

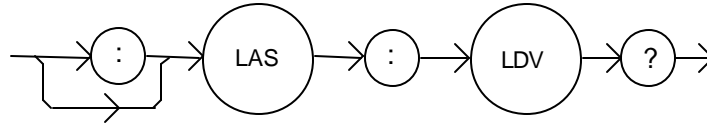

-where the response is the measured laser output voltage, for either low or high bandwidth modes.

POINTS OF INTEREST

This measurement is updated approximately once every 600 msec.

EXAMPLES

"LAS:ldv?" -response: 3.03, means the measured laser output voltage is 3.03 volts.

"Laser:LDV?" -response: 1.0, means the measured laser output voltage is 1.000 volt.

- Front Panel
- Remote

LASer:LIMit:I1

The LASer:LIMit:I1 command sets the LASER current limit value for the 100 mA range on the LDX-3210. (Not applicable for LDX-3220).

SYNTAX DIAGRAM

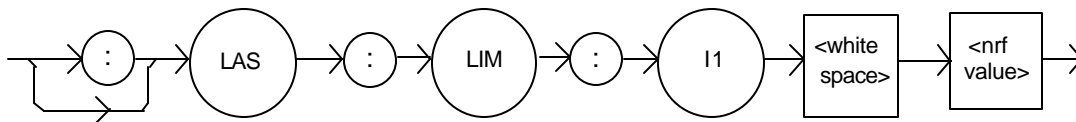

PARAMETERS An <nrf value> which represents the LASER limit current, in mA.

POINTS OF INTEREST

The current limit is in effect in all modes of operation (ILBW, IHBW, or P). The current limit in use depends on the LASER output range selection.

EXAMPLES

"LAS:LIM:I1 80" -action: the LASER current limit is set to 80 mA.

":Laser:Limit:I1 60" -action: the LASER current limit is set to 60 mA.

- Front Panel
- Remote

LASer:LIMit:I1?

The LASer:LIMit:I1? query returns the value of the LASER current limit for the 100 mA range on the LDX-3210. (Not applicable for LDX-3220).

SYNTAX DIAGRAM

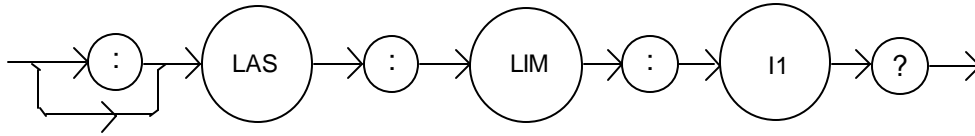

-where the response is the current limit for the 100 mA range (LDX-3210).

POINTS OF INTEREST

The current limit is in effect in all modes of operation (ILBW, IHBW, or P). The current limit in use depends on the LASER output range selection.

EXAMPLES

"LAS:LIM:I1?" -response: 40, means the laser current limit is 40 mA.

"Laser:LIM:I1?" -response: 50, means the laser current limit is 50 mA.

- Front Panel
- Remote

LASer:LIMit:I2

The LASer:LIMit:I2 command sets the LASER current limit value for the 200 mA range on the LDX-3220. (Not applicable for LDX-3210).

SYNTAX DIAGRAM

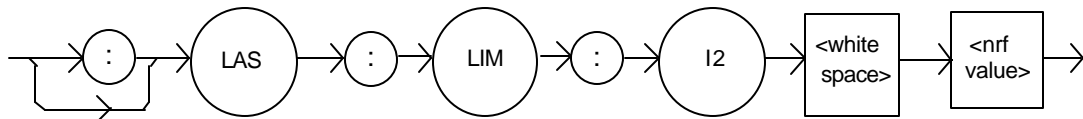

PARAMETERS An <nrf value> which represents the LASER limit current, in mA.

POINTS OF INTEREST

The current limit is in effect in all modes of operation (ILBW, IHBW, or P). The current limit in use depends on the LASER output range selection.

EXAMPLES

"LAS:LIM:I2 180" -action: the LASER current limit is set to 180 mA.

":Laser:Limit:I2 160" -action: the LASER current limit is set to 160 mA.

- Front Panel
- Remote

LASer:LIMit:I2?

The LASer:LIMit:I2? query returns the value of the LASER current limit for the 200 mA range on the LDX-3220. (Not applicable for LDX-3210).

SYNTAX DIAGRAM

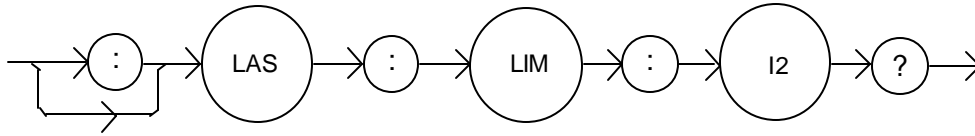

-where the response is the current limit value for the 200 mA range (LDX-3220).

POINTS OF INTEREST

The current limit is in effect in all modes of operation (ILBW, IHBW, or P). The current limit in use depends on the LASER output range selection.

EXAMPLES

"LAS:LIM:I2?" -response: 40, means the laser current limit is 40 mA.

"Laser:LIM:I2?" -response: 150, means the laser current limit is 150 mA .

- Front Panel
- Remote

LASer:LIMit:I5

The LASer:LIMit:I5 command sets the LASER current limit value for the 50 mA range on the LDX-3210 and the 500 mA range on the LDX-3220.

SYNTAX DIAGRAM

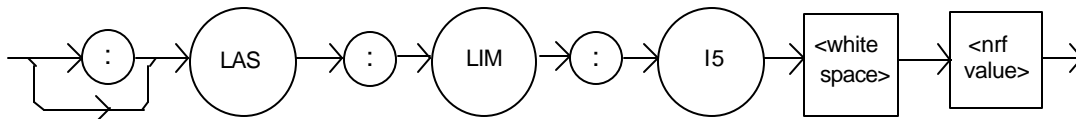

PARAMETERS An <nrf value> which represents the LASER limit current, in mA.

POINTS OF INTEREST

The current limit is in effect in all modes of operation (ILBW, IHBW, or P). The current limit in use depends on the LASER output range selection.

In local operation, the limit current is entered by selecting **LIM I** parameter, pressing and holding in the (PARAMETER) **SET** switch, adjusting the knob until the desired value is displayed, and then releasing the **SET** switch.

EXAMPLES

"LAS:LIM:I5 50" -action: the LASER current limit is set to 50 mA.

":Laser:Limit:I5 160" -action: the LASER current limit is set to 160 mA (LDX-3220 only).

- Front Panel
- Remote

LASer:LIMit:I5?

The LASer:LIMit:I5? query returns the value of the LASER current limit for the 50 mA range on the LDX-3210 or the 500 mA range on the LDX-3220.

SYNTAX DIAGRAM

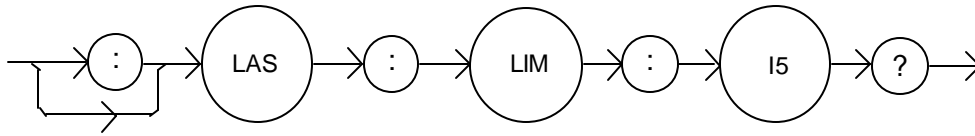

-where the response is the current limit value for the 50 mA range (LDX-3210) or 500 mA range (LDX-3220).

POINTS OF INTEREST

The current limit is in effect in all modes of operation (ILBW, IHBW, or P). The current limit in use depends on the LASER output range selection.

EXAMPLES

"LAS:LIM:I5?" -response: 400, means the laser current limit is 400 mA (LDX-3220 only).

"Laser:LIM:I5?" -response: 50, means the laser current limit is 50 mA.

- Front Panel
- Remote

LASer:LIMit:MDP

The LASer:LIMit:MDP command sets the laser monitor photodiode power limit value.

SYNTAX DIAGRAM

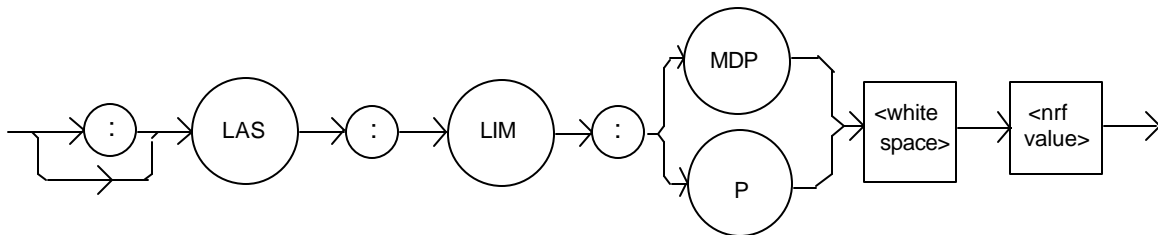

PARAMETERS

An <nrf value> which represents the laser monitor photodiode power limit, in mW.

POINTS OF INTEREST

When constant MDP mode is used, the output level is limited only by the LIM Ix value. Exceeding the power limit will either cause the output to shut off (default), or just generate a warning (see LAS:ENAB:OUTOFF command).

XAMPLES "LAS:LIM:MDP 10" -action: sets the laser output power limit to a value which corresponds to producing 10.00 mW of PD feedback (optical) power.

"Las:Limit:MDp 5" -action: sets the laser output power limit to a value which corresponds to producing 5.00 mW of PD feedback (optical) power.

- Front Panel
- Remote

LASer:LIMit:MDP?

The LASer:LIMit:MDP? query returns the value of the laser monitor PD power limit.

SYNTAX DIAGRAM

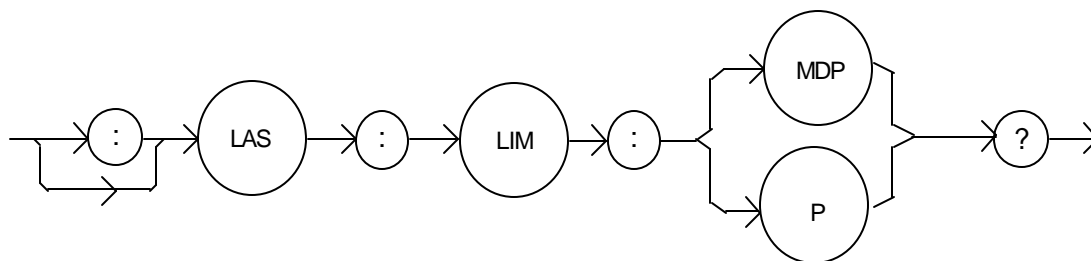

-where the response is the LASER power limit setting.

POINTS OF INTEREST

The (LASER) MDP limit is in effect for both laser output current ranges.

The MDP limit is not in effect when CALMD = 0. In this case, the monitor current measurement is not converted to power.

EXAMPLES "LAS:LIM:MDP?" -response: 3.0, means the monitor PD power limit is set to 3.0 mW.

"LAS:Limit:MDP?" -response: 10.0, means the monitor PD power limit is set to 10.0 mW.

- Front Panel
- Remote

LASer:LIMit:V

The LASer:LIMit:V command sets the LASER compliance voltage limit value.

SYNTAX DIAGRAM

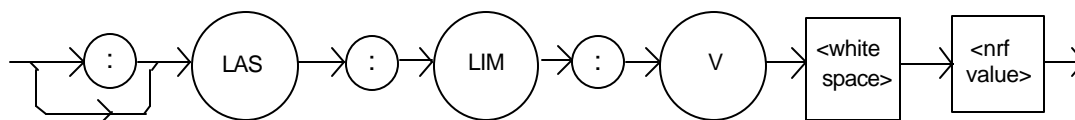

PARAMETERS An <nrf value> which represents the LASER limit voltage, in volts.

POINTS OF INTEREST

The voltage limit setting is useful for laser protection. When the maximum operating voltage of a laser is known, the user may set the voltage limit to a value slightly higher than the maximum operating voltage. Then, if the laser is accidentally disconnected, the current source will quickly sense the over-voltage and shut off.

In local operation, the voltage limit is entered by selecting the **COMP V**, then pressing and holding in the (PARAMETER) **SET** switch. Turn the adjust knob until the desired value is displayed, and then release the **SET** switch.

EXAMPLES

"LAS:LIM:V 5.0" -action: the LASER compliance voltage limit is set to 5.0 volts.

":Laser:Limit:V 4.60" -action: the LASER compliance voltage limit is set to 4.6 volts.

- Front Panel
- Remote

LASer:LIMit:V?

The LASer:LIMit:V? query returns the value of the LASER compliance voltage limit setting.

SYNTAX DIAGRAM

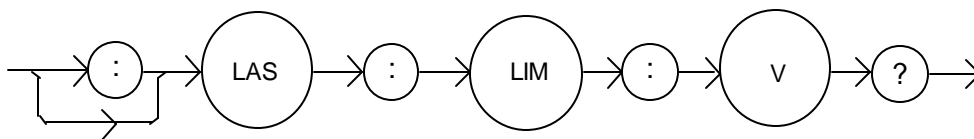

-where the response is the LASER limit voltage set point.

POINTS OF INTEREST

The voltage limit is valid for all modes of Laser operation.

In local operation, the voltage limit is read by selecting the **COMP V** parameter via the (PARAMETER) **SELECT** switch.

EXAMPLES

"LAS:LIM:V?" -response: 4.5, means the laser compliance voltage limit is 4.5 volts.

":Laser:LIM:V?" -response: 10.0, means the laser compliance voltage limit is set to 10.0 volts.

- Front Panel
- Remote

LASer:MDI

The LASer:MDI command sets the value of the optical power set point, in μA , if the CALMD (CAL PD) responsivity is 0.

SYNTAX DIAGRAM

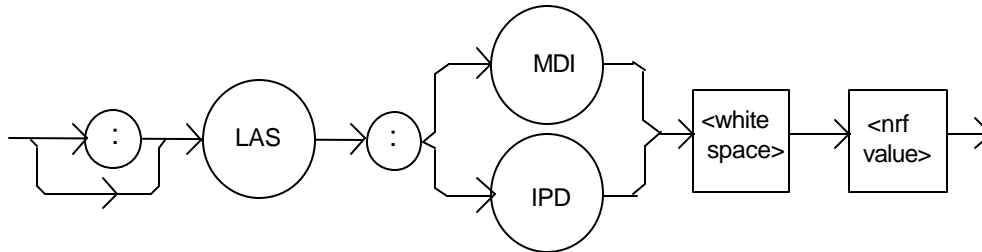

PARAMETERS An <nrf value> which represents the photodiode feedback current, in μA .

POINTS OF INTEREST

If the CALMD (CAL PD) parameter is not set to 0, the LAS:MDI value will not be used. In this case, the measured MDI would be converted to MDP (P_{PD} , by the CAL PD factor), and the MDP (P_{PD}) set point would be used.

EXAMPLES

"Las:Mdi 40" -action: The LASER output is controlled so that the photodiode feedback current remains constant at 40 μA .

"Laser:MDI 200" -action: The LASER output is controlled so that the photodiode feedback current remains constant at 200 μA .

- Front Panel
- Remote

LASer:MDI?

The LASer:MDI? query returns the value of the laser photodetector current measurement, in μA .

SYNTAX DIAGRAM

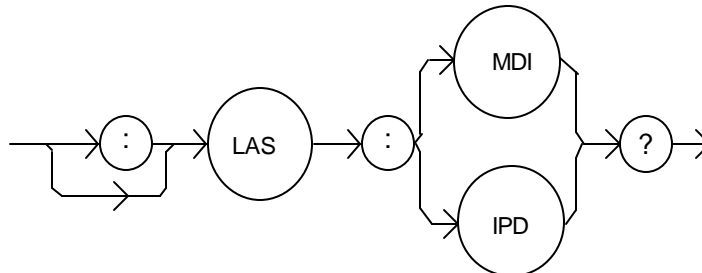

-where the response is the most recent LASER monitor current measurement.

POINTS OF INTEREST

The response is in μA . The response is valid, even when the unit is not in constant P mode.

This measurement is updated approximately once every 600 msec.

EXAMPLES

"Las:Mode:MDP; Las:Calmd 0; Las:MDi?" -response: 100.0, means 100 μA of photodetector current. This feedback is controlling the laser current output.

"LAS:MODE:IHBW; LAS:MDI?" -response: 20.0, means 20 μA of photodetector current, but photodiode monitor current is not controlling the laser output current.

- Front Panel
- Remote

LASer:MDLN

The LASer:MDLN command enables or disables (turns off) the front panel modulation input (BNC).

SYNTAX DIAGRAM

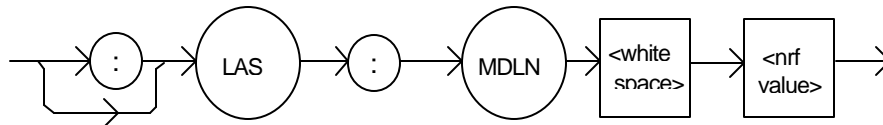

PARAMETERS An <nrf value> -where 1 = on, 0 = off.

POINTS OF INTEREST

After turning the modulation off, it will remain off until turned back on via this command or by resetting the instrument.

EXAMPLES

"las:mdl n 1" -action: turns the modulation input on and enables modulation via the front panel BNC connector.

"Laser:mdl n 0" -action: turns the modulation input off. Modulation signals at the front panel BNC will not effect the LAS output.

- Front Panel
- Remote

LASer:MDLN?

The LASer:MDLN? query returns the status of the LAS modulation control. When disabled, a modulation signal at the front panel BNC will not effect the LAS output.

SYNTAX DIAGRAM

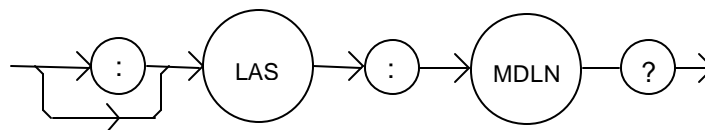

-where the response of 1 = on, 0 = off.:

POINTS OF INTEREST

The LASER modulation control switches the front panel BNC in and out of the LAS control circuit. At power-up or after reset, modulation is enabled by default.

EXAMPLES

"LAS:MDLN?" -response: 1, means that the LAS modulation input is enabled.

"las:mdln?" -response: 0, means that the LAS modulation input is disabled.

- Front Panel
- Remote

LASer:MDP

The LASer:MDP command sets the value of the optical power set point, in mW, if the CALMD (CAL PD) responsivity is greater than 0.

SYNTAX DIAGRAM

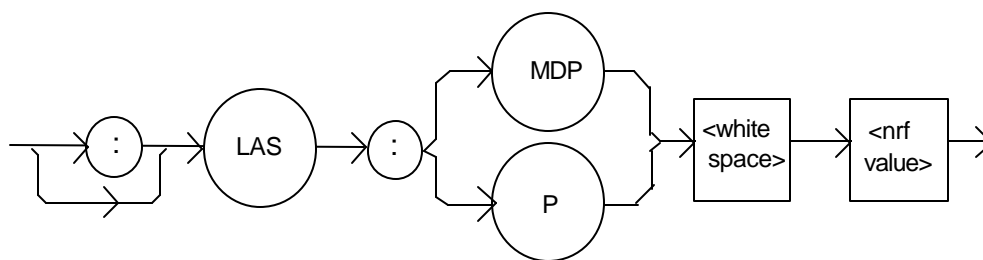

PARAMETERS

An <nrf value> which represents the photodiode feedback power, in mW.

POINTS OF INTEREST

If the CALMD (CAL PD) parameter is set to 0, the LAS:MDP value will not be used. In this case, the measured MDP would be invalid, and the MDI (I_{PD}) set point would be used.

EXAMPLES

"Las:Mdp 40" -action: The LASER output is controlled so that the photodiode feedback power remains constant at 40 mW.

"Laser:MDP 200" -action: The LASER output is controlled so that the photodiode feedback power remains constant at 200 mW.

- Front Panel
- Remote

LASer:MDP?

The LASer:MDP? query returns the value of the laser photodetector power measurement, in mW.

SYNTAX DIAGRAM

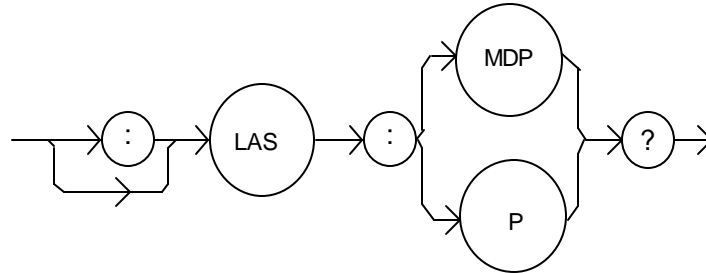

-where the response is the most recent LASER power measurement.

POINTS OF INTEREST

The response is in mW. The response is valid, even when the unit is not in constant P mode.

This measurement is updated approximately once every 600 ms ec.

EXAMPLES

"Las:Mode:MDP; Las:Calmd 460; Las:MDp?" -response: 100.0, means 100 mW of photodetector power. This feedback is controlling the laser current output.

"LAS:MODE:IHBW; LAS:MDP?" -response: 20.0, means 20 mW of photodetector power, but photodiode monitor current is not controlling the laser output current.

- Front Panel
- Remote

LASer:MODE?

The LASer:MODE? query returns the selected laser control mode.

SYNTAX DIAGRAM

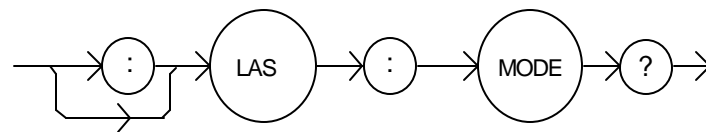

-where the response is the LASER control mode.

POINTS OF INTEREST

I_{HBW} mode is the same as I mode (low bandwidth), except that the output low bandpass filter is disabled in I_{HBW} mode.

EXAMPLES "LAS:MODE?" -response: ILBW, means that constant I (current) mode is in effect for the laser output.

":Las:Mode?" -response: MDP, means that constant P (power) mode is in effect for the laser output, and CALMD > 0.

"Las:Mode?" -response: MDI, means that constant P (power) mode is in effect for the laser output, and CALMD = 0.

"Laser:MODE?" -response: IHBW, means that constant I_{HBW} (current, high bandwidth) mode is in effect for the laser output.

■ Front Panel

LASer:MODE:IHBW

■ Remote

The LASer:MODE:IHBW command selects laser high bandwidth constant current mode.

SYNTAX DIAGRAM

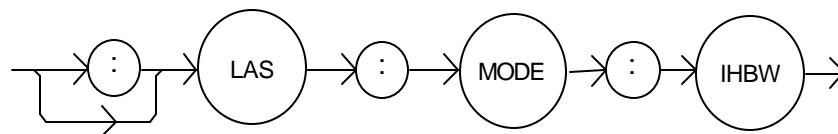

PARAMETERS None.

POINTS OF INTEREST This mode of operation is constant I mode with the output lowpass filter disabled.

EXAMPLES "LAS:Mode:Ihbw" -action: enables the laser high bandwidth constant current mode.

■ Front Panel

LASer:MODE:ILBW

■ Remote

The LASer:MODE:ILBW command selects laser constant current mode.

SYNTAX DIAGRAM

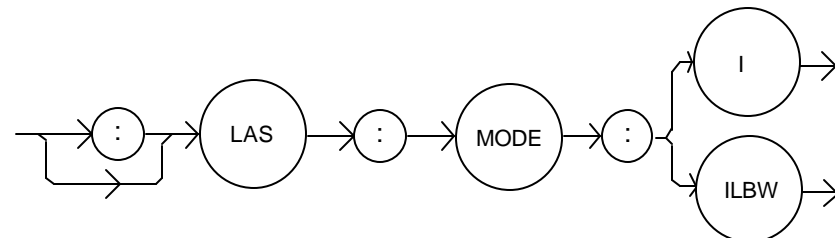

PARAMETERS None.

POINTS OF INTEREST Constant I mode (low bandwidth) enables the output low bandpass filter.

EXAMPLES "LAS:MODE:ILBW" -action: sets the laser output for constant I mode (low bandwidth).

- Front Panel
- Remote

LASer:MODE:MDP

The LASer:MODE:MDP command selects laser constant power mode.

SYNTAX DIAGRAM

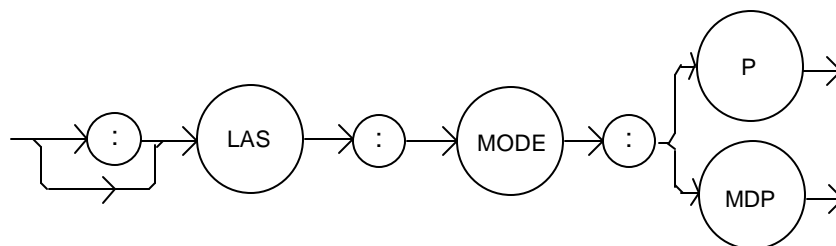

PARAMETERS None.

POINTS OF INTEREST This mode of laser operation requires the laser's monitor PD feedback to maintain constant optical power or constant monitor current.

In this mode, the displayed parameter will be either I_{PD} (if CALMD = 0) in μA , or P_{PD} (if CALMD > 0) in mW.

EXAMPLES "LAS:MODE:MDP" -action: sets the laser output mode of operation to constant optical power mode.

- Front Panel
- Remote

LASer:OUTput

The LASer:OUTput command turns the laser output on or off.

SYNTAX DIAGRAM

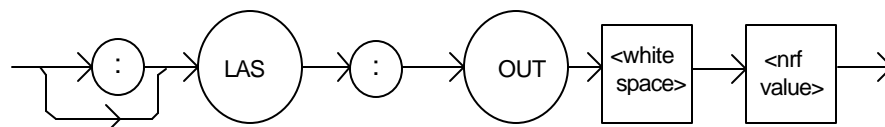

PARAMETERS An <nrf value>; 1 = on, 0 = off.

POINTS OF INTEREST

There is a 2-second delay after the output is turned on before the output shorting relay is opened. Following this, the output current ramps up to the current set point slowly to protect the laser. Therefore, the time to turn the output on and reach the set point current varies from 2 to about 3 seconds.

After the output is turned on, it may be useful to wait until the output is stable (within tolerance) before performing further operations, but it is not necessary. When the LASER output is off, it is safe to connect or disconnect devices to the LASER output terminals.

When the LASER output is off, an internal short is placed across the output terminals.

EXAMPLES

"LAS:I 20; LAS:OUT ON" -action: sets the laser output current to 20 mA and then turns the output on.

- Front Panel
- Remote

LASer:OUTput?

The LASer:OUTput? query returns the status of the laser output switch.

SYNTAX DIAGRAM

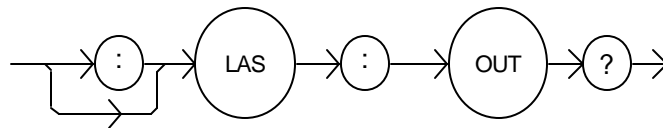

-where the response is 0 or 1.

POINTS OF INTEREST

Although the status of the switch is on, the output may not have reached the set point value.

EXAMPLES

"Las:OUT?" -response: 0, means that the output switch is disabled, devices may be safely disconnected or connected at the LASER output terminals.

"LAS:OUT?" -response: 1, means that the LASER output switch is enabled, LASER output is present.

- Front Panel
- Remote

LASer:RANge

The LASer:RANge command selects the laser's drive current output range.

SYNTAX DIAGRAM

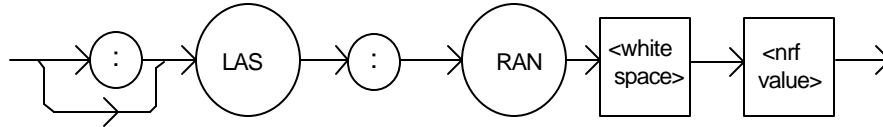

PARAMETERS An <nrf value> which represents the laser current output range.

For LDX-3210: 5 = 50 mA, and 1 = 100 mA range.

For LDX-3220: 2 = 200 mA, and 5 = 500 mA range.

POINTS OF INTEREST

This range setting effects the Laser Drive Current output current range only.

The Laser Drive Current output should be "off" when this command is issued. If the Laser Diode Current output is "on" when this command is issued, the LDX-3200 Series Precision Current Source will generate error E515, and the range will not be changed.

EXAMPLES

"LAS:RAN 2" -action: sets the laser output drive current range to 200 mA (LDX-3220 only).

"Laser:range 1" -action: sets the laser output drive current range to 100 mA (LDX-3210 only).

- Front Panel
- Remote

LASer:RANge?

The LASer:RANge? query returns the value of the Laser Drive Current range.

SYNTAX DIAGRAM

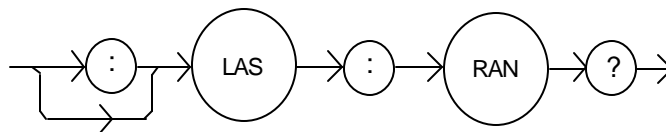

-where the response is an integer; 1 means 100 mA range (LDX-3210), 2 means 200 mA range (LDX-3220), and 5 means 50 mA range (LDX-3210) or 500 mA range (LDX-3220).

POINTS OF INTEREST

The resolution and accuracy of the laser limit current are dependent on the Laser Drive Current output range.

EXAMPLES "LAS:RAN?" -response: 1, means that the Laser Drive Current range is 100 mA (LDX-3210 only).

"LAS:range?" -response: 2, means that the Laser Drive Current range is 200 mA (LDX-3220 only).

- Front Panel
- Remote

LASer:SET:LDI?

The LASer:SET:LDI? query returns the constant I value which is used for both output ranges and both bandwidths.

SYNTAX DIAGRAM

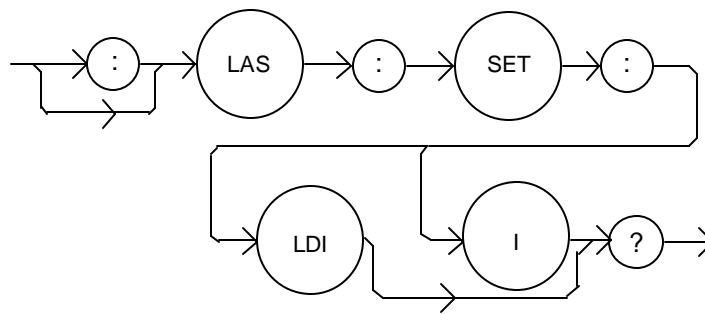

-where the response is the constant I set point value, in mA.

POINTS OF INTEREST

In local operation, the constant I set point is read by selecting I or IHBW mode, then pressing and holding down the **SELECT** switch in the DISPLAY area of the front panel. When the mA indicator is blinking, the display will show the LDI set point.

EXAMPLES "LAS:SET:LDI?" -response: 50.0, means the laser output current set point value is 50.0 mA.

"Laser:set:ldi?" -response: 120.0 means the laser output current set point value is 120.0 mA (LDX-3220 only).

- Front Panel
- Remote

LASer:SET:MDI?

The LASer:SET:MDI? query returns the laser monitor PD current set point value (when CALPD = 0), in μA .

SYNTAX DIAGRAM

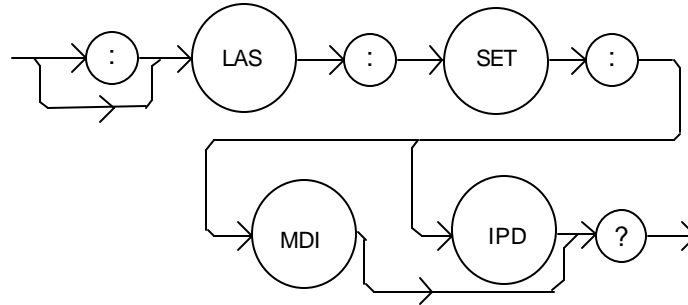

-where the response is the constant I_{PD} set point value, in μA .

POINTS OF INTEREST

In local operation, the MDI set point is read by selecting P mode, then pressing and holding down the **SELECT** switch in the DISPLAY area of the front panel. When the μA indicator is blinking, the display will show the MDI set point.

The monitor photodiode current is directly proportional to the laser optical output power. Therefore, the MDI (I_{PD}) set point may be used to control optical output of the laser.

EXAMPLES

"las:set:mdi?" -response: 30.0, means the laser monitor PD current is set point is 30 μA , for use in constant P mode with CALPD = 0.

"LAS:Set:MDI?" -response: 100.0 means the laser monitor PD current is set point is 100 μA , for use in constant P mode with CALMD = 0.

- Front Panel
- Remote

LASer:SET:MDP?

The LASer:SET:MDP? query returns the laser monitor PD power set point value (when CALMD [CAL PD] is not zero), in mW.

SYNTAX DIAGRAM

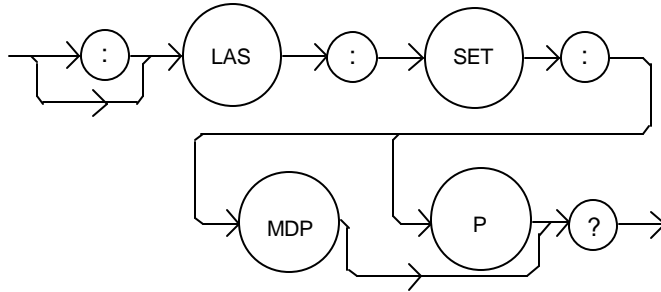

-where the response is the constant P_{PD} set point, in mW.

POINTS OF INTEREST

In local operation, the MDP set point is read by selecting P mode, then pressing and holding down the **SELECT** switch in the DISPLAY area of the front panel. When the mW indicator is blinking, the display will show the MDP set point.

This set point is used in constant MDP mode only.

EXAMPLES

"LAS:Set:MDP?" -response: 10.0, means the laser monitor PD feedback set point is 10.0 mW (CALPD > 0).

"Laser:Set:MDP?" -response: 25.0, means the laser monitor PD feedback set point is 25.0 mW (CALPD > 0).

- Front Panel
- Remote

LASer:STEP

The LASer:STEP command is used to increment or decrement the selected laser control mode set point by the given amount, when used with the LASer:INC or LASer:DEC command.

SYNTAX DIAGRAM

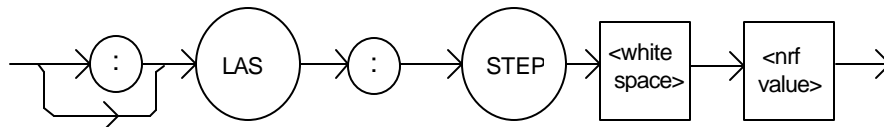

PARAMETERS An integer value of the step amount, in the range 1 to 9999.

POINTS OF INTEREST

The step of 1 corresponds to the smallest display resolution for the mode. For example, a step of 1 means 0.01 mA (LDX-3220) or 0.002 mA (LDX-3210, 100 mA range) or 0.001 mA (LDX-3210, 50 mA range), 0.01 mW, or 1 μ A (if CALPD = 0).

EXAMPLES

"Las:Mode;i; Las:Idi 20; Las:Step 100; Las:Inc; Las:set:Idi?" -action: sets the step to 1.0 mA (LDX-3220), so the Las:set:Idi? query will return a value of 21.0 mA.

"LAS:STEP 1000" -action: sets the step size to 1000; could mean 10.0 mA (LDX-3220), 10.0 mW, or 100 μ A.

- Front Panel
- Remote

LASer:STEP?

The LASer:STEP? query is used to read back the LASer STEP value. This value is used to increment or decrement the selected laser control mode set point by the given amount, when used with the LASer:INC or LASer:DEC command.

SYNTAX DIAGRAM

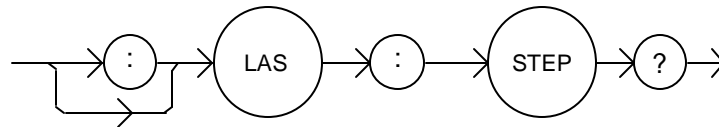

-where the response is an integer value.

EXAMPLES

"Las:Mode:LDI; Las:Step?" -response: 1 means the step size is 0.01 mA (LDX-3220), since Const I mode is in effect.

"LAS:MODE:MDP; LAS:CALMD 1; LAS:STEP?" -response: 10 means the step size is 0.1 mW, since Const P mode is in effect.

- Front Panel
- Remote

LASer:TOLerance

The LASer:TOLerance command allows the programmer to determine the LASER current tolerance, and time window for it to occur, in order that the operation complete flag be set after a "LASer:OUTput 1" command is issued, or the LASER set point is changed.

SYNTAX DIAGRAM

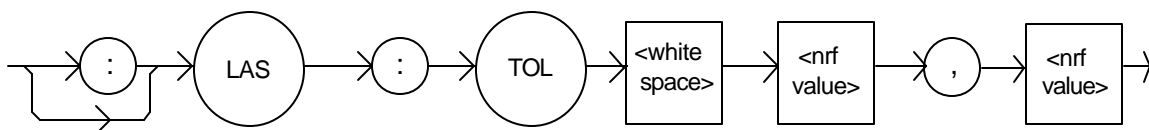

PARAMETERS Two <nrf values>; the first represents the LASER current tolerance, in mA, with a range of 0.1 to 100.0 mA; and the second represents the time window, in seconds, with a range of 0.001 to 50.000 seconds.

POINTS OF INTEREST The LDX-3200 Series Precision Current Source defaults to a tolerance of 10.0 mA for 5 seconds, unless changed by the LASer:TOLerance command.

If the LDX-3200 Series Precision Current Source is operated in P mode, the current tolerance parameter is not used. Instead a fixed value of 50 μ A is used for the I_{PD} current. A fixed value of 1 mW (LDX-3210 or LDX-3220) is used for P_{PD} power, and only the time window parameter may be adjusted.

NOTE

If the tolerance is set too tight it may never be achieved. This is due to the calibration of the set point and measurement values.

EXAMPLES "Las:Tol 0.5,10" -action: the LDX-3200's LASER current source will be in tolerance when the LASER current is within 0.5 mA for 10.000 seconds.

- Front Panel
- Remote

LASer:TOLerance?

The LASer:TOLerance? query allows the programmer to determine how the LASER current tolerance is set.

SYNTAX DIAGRAM

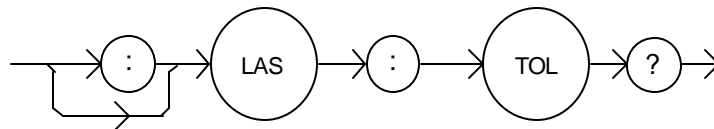

-where the response consists of two values, the first is the current tolerance, in mA; and the second is the time window, in seconds.

POINTS OF INTEREST The tolerance of the LDX-3200 Series Precision Current Source LASER current may be used to delay programming after an "LASer:OUTput 1" command is issued or the set point is changed.

A change of the output into or out of tolerance flag sets a flag in the LASER status event register, and so entering or exiting LASER current tolerance may be used to generate service requests.

EXAMPLES "Las:Tol?" -response: "0.2,5.0", means the LDX-3200 Series Precision Current Source has a LASER current tolerance setting of 0.2 mA with a time window of 5.000 seconds.

"LASER:TOL?" -response: "1.0,20.0", means the LDX-3200 Series Precision Current Source has a LASER current tolerance setting of 1.0 mA with a time window of 20.000 seconds.

- Front Panel
- Remote

MESsage

The MESsage command allows the user to enter an ASCII string of up to 16 non-NULL characters. This command may be useful for storing messages which relate to a test or configuration.

SYNTAX DIAGRAM

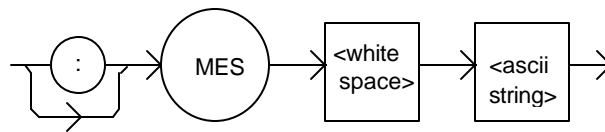

PARAMETERS An ASCII string that is 1 - 16 bytes in length.

POINTS OF INTEREST

The message may contain any ASCII character, but will be terminated when a NULL terminator character is received. If the message has less than 16 bytes, the software will fill the remaining message space with the space character. After 16 bytes have been entered, the software will null-terminate the string.

EXAMPLES MESSAGE "This is a test." -action: The string, "This is a test. " will be stored in non-volatile memory.

Mes "Test 3" -action: The string, "Test 3 " will be stored in non-volatile memory.

- Front Panel
- Remote

MESsage?

The MESsage? query returns the previously stored message. This message will always be 16 bytes long and enclosed in quotes. The message is entered via the MESsage command.

SYNTAX DIAGRAM

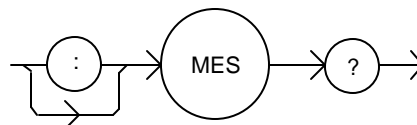

-where the response is a 16-byte long character string.

POINTS OF INTEREST

The response data will be a 16-byte long string. If there is no previously stored message, the response will be " ", all spaces.

EXAMPLES

"MES?" -response: "Test 3 ", means the previously stored message was "Test 3".

"Message?" -response: "This is a test. ", means the previously stored message was "This is a test."

- Front Panel
- Remote

RADix

The RADix command allows the programmer to select the radix type for status, condition, and event query response data. Decimal, binary, hexadecimal, and octal are allowed.

SYNTAX DIAGRAM

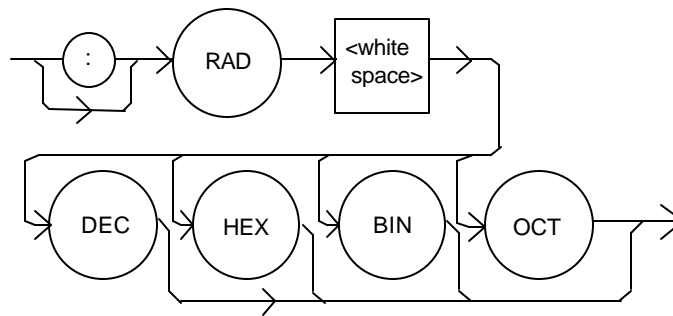

PARAMETERS

Character program data is expected, as shown above.

POINTS OF INTEREST

DECimal is the default type. Only the first three letters of the words decimal, hexadecimal, binary, or octal are required.

When the RADIX is selected, all status, condition, and event queries will return values in the new radix.

In the cases where the radix is not DECimal, the flexible numeric type <nrf value> (as shown in the Command Reference diagrams) will be replaced by HEX, BIN, or OCT representation.

All of the above radices may be used to enter program data at any time, without the need for issuing the RADix command. The proper prefix must also be used with Hex (#H), binary (#B), or octal (#Q).

This command may be useful for setting up status reporting blocks. The bit-wise status representation may be more easily read in BIN, HEX, or OCT.

EXAMPLES "RAD dec" -action: the decimal radix is selected.

"rad hex; *ESR?" -action: the hexadecimal radix is selected; -response: #H80, means power-on was detected.

Front Panel

Remote

RADix?

The RADix? query allows the programmer to determine which radix type for status, condition, and event query response data is currently selected. Decimal, binary, octal, and hexadecimal are allowed.

SYNTAX DIAGRAM

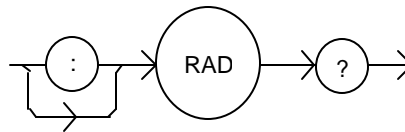

-where the character response data of DEC means decimal, BIN means binary, HEX means hexadecimal, and OCT means octal.

POINTS OF INTEREST

DEC is the default type. The LDX-3200 Series Precision Current Source defaults to this radix at power-up.

The RADix command is used to select the desired radix. Once it is changed, the new radix will remain in effect until the power is shut off or a new RADix command is issued.

EXAMPLES "RAD?" -response: Dec, means the selected radix is decimal.

"rad?" -response: Hex, means the selected radix is hexadecimal.

"RADIX?" -response: Oct, means the selected radix is octal.

Front Panel

Remote

SECURE

The SECURE command allows the service technician access to the protected user data command, *PUD, which is a common command. This data is normally changed only at the factory, and therefore the SECURE command is not needed by the user.

The TERM command allows the programmer to change the default (IEEE488.2 standard) terminator to include the carriage return.

SYNTAX DIAGRAM

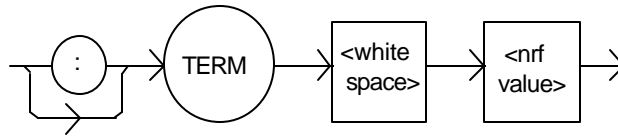

PARAMETERS An <nrf value>, 0 = FALSE, non-zero = TRUE

POINTS OF INTEREST

An altered terminator will be in the form <CR><NL><^END>. This technically takes the LDX-3200 Series Precision Current Source out of IEEE488.2 specification, but may be done for convenience when using non-standard GPIB interfaces. This termination will be sent with all output until the "TERM 0" command is sent or the LDX-3200 Precision Current Source is powered off.

EXAMPLES

"Term 1" -temporarily sets <CR><NL><^END> as the output terminator.

"Term 0" -sets the IEEE488.2 standard <NL><^END> terminator. This is the LDX-3200 Series' default value.

The TERM? query allows the programmer to determine whether the default (IEEE488.2 standard) terminator has been altered to include a carriage return.

SYNTAX DIAGRAM

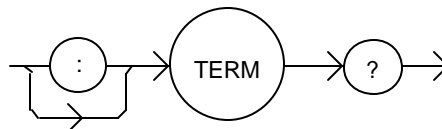

-where the response is 0 or 1.

POINTS OF INTEREST

An altered terminator will be in the form <CR><NL><^END>. This termination will be sent with all output until the "TERM 0" command is sent or the LDX-3200 Series Precision Current Source is powered off.

EXAMPLES "Term?" -response: 1, means that the <CR><NL><^END> terminator is temporarily being used.

"Term?" -response: 0, means that the <NL><^END> terminator (IEEE488.2 standard) is being used.

- Front Panel
- Remote

TIME?

The TIME? query allows the programmer to determine how much time has passed since the LDX-3200 Series Precision Current Source was last powered up.

SYNTAX DIAGRAM

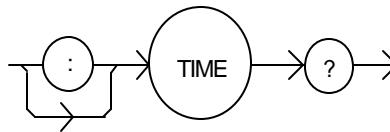

-where the response is character data in the form: hours:minutes:seconds.

POINTS OF INTEREST

The TIME clock is independent of the TIMER clock.

EXAMPLES

"Time?" -response: 1:02.36, means that 1 minute and 2.36 seconds have passed since the LDX-3200 Series Precision Current Source was powered up.

"TIME?" -response: 32:00.76, means that 32 minutes and 0.76 seconds have passed since the LDX-3200 Series Precision Current Source was powered up.

- Front Panel
- Remote

TIMER?

The TIMER? query allows the programmer to determine how much time has passed since the last TIMER? query was issued.

SYNTAX DIAGRAM

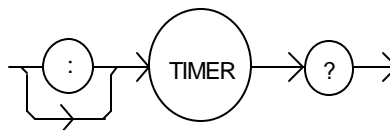

-where the response is character data which represents hours:minutes:seconds.

**POINTS OF
INTEREST**

Each time the `TIMER?` query is issued, the timer is reset to 0 and the elapsed time since the last `TIMER?` query is returned.

The timer counter is initially set at power-up, the same as the `TIME?` counter. So the first time the `TIMER?` is issued its response will be the same as if a `TIME?` query's response.

EXAMPLES

"Timer?" -response: 00:02:00.31, means the LDX-3200 Series Precision Current Source has been on for 2 minutes and 0.31 seconds since the last `TIMER?` query was issued.

"TIMER?" -response: 00:00:12.03, means the LDX-3200 Series Precision Current Source has been on for 12.03 seconds since the last `TIMER?` query was issued.

CHAPTER 5	1
FUNCTIONS AND FEATURES	1
Introduction	1
Saving and Recalling from the Front Panel	1
Saving and Recalling under remote operation	1
Using the LASER COMPLIANCE VOLTAGE ADJUSTMENT	2
Using the LDX-3200 Current Source's Trigger Function	2
Modulating the Laser Current Source	3

CHAPTER 5

FUNCTIONS AND FEATURES

INTRODUCTION

This chapter introduces you to the LDX-3200 Series Precision Current Source functions and operating features such as event triggering, analog modulation of laser injection current, and Save and Recall.

SAVING AND RECALLING FROM THE FRONT PANEL

For applications where you might need to alternate between particular instrument configurations, the LDX-3200 Current Sources offer a unique SAVE and RECALL feature. The SAVE feature allows you to easily store all front panel settings for any given instrument configuration. These settings, which are stored in one of ten memory bins, can be retrieved at any time with the RECALL function. This saves setup time, and it reduces the chance of setup error for tests which are periodically repeated. For example, using the configuration described in Chapter 2 where the Current Source is operating in Constant Current mode, the instrument parameters saved by using the SAVE function would be Constant Current Mode, 200 mA range, a limit set point of 175 mA, a laser current set point of 150 mA, and Display Mode I. Once this set up is saved, the LDX-3200 Current Source may be configured for another unique set up. You can recall the original set up for the first experiment any time using the RECALL function.

To enter the **SAVE/RECALL** mode, press the **SELECT** switch in the **PARAMETER** section until the **SAVE** indicator LED becomes lit and the unit displays the **SAVE** "bin" on the display. If another bin number is desired, press the **SET** switch and rotate the adjust knob until the desired bin number is displayed. Releasing the **SET** switch completes the **SAVE** operation and all of the instrument parameters are saved to the indicated bin number as they appear on the front panel.

To recall a previously saved instrument set up, press the **SELECT** switch until the **RECALL** indicator led becomes lit. The instrument will display a **RECALL** "bin" number on the display. If you desire to change the **RECALL** bin, press the **SET** switch and rotate the adjust knob until the desired bin number is displayed. Releasing the **SET** switch completes the **RECALL** operation. The instrument is restarted and the front panel parameters are reconfigured to the new parameters saved under that bin number.

The factory default values for front panel parameters may be restored by recalling "bin" zero (0). See Table 2.1 for the default settings.

SAVING AND RECALLING UNDER REMOTE OPERATION

For saving under remote operation, use the command `"*SAV x"`, where x is the desired "bin" number (1-10). For a recall under remote operation, use the command `"*RCL x"`, where x is the desired "bin" number (0 – 10).

USING THE LASER COMPLIANCE VOLTAGE ADJUSTMENT

For applications where you need to have critical protection of the laser we recommend the following. Using a one ohm resistor or other non-critical load, set the LASER voltage limit as described in Chapter 2.

Then with the LASER output on, slowly increase the LASER current and watch the LASER voltage measurement. Press the **(DISPLAY) SELECT** push button to see the voltage. At about 0.25 volts below the LASER voltage limit value, the VOLTAGE LIMIT warning indicator will become lit on the display. Continue to adjust the current up until the voltage limit is reached and the output is shut off. Record the voltage at which the LASER output shuts off. It should be within the specification of the LASER voltage limit accuracy. However, there is typically some offset error. For example, if the LASER voltage limit is set to 5.0 volts, the actual voltage where it shuts off may be 4.9 volts. This error term of 0.1 volts should be considered when setting the LASER compliance voltage limit.

The closer the LASER voltage limit shut off point is to the operating voltage of your laser, the faster the circuit will work in the event of an open circuit. Some experimentation may be necessary for optimum results.

USING THE LDX-3200 CURRENT SOURCE'S TRIGGER FUNCTION

For applications where you need to synchronously initiate a measurement task from a remote instrument with the LDX-3200 Current Source, the Current Source offers a trigger output signal. The TTL pulse is initiated with any remote change in set point of the laser current source. A typical application for utilization of this feature is laser characterization tasks where an L-I curve is generated. For a programmed step in laser current, a light measurement can be triggered for each step in laser current. The trigger output is enabled only in remote mode via the IEEE 488.2 GPIB Interface.

The trigger output is available via a standard BNC connector on the rear panel of the LDX-3200 Current Source. See Figure 5.1. The TTL pulse is approximately 13 μ sec wide and has a delay time of about 10 – 12 msec after the current set point is changed via GPIB. This delay does not include the GPIB transmission time. The time for any command to be sent via GPIB depends on the interface hardware and software control. The current set point may be changed by the LAS:LDI, LAS:INC, or LAS:DEC commands.

NOTE

The minimum step change time required for a corresponding trigger pulse is 20 msec. Care should be used with respect to the timing of any set point commands in relation to the actual hardware function. The INC and DEC commands have a minimum step time of about 20 msec which allows for the hardware initiation of a set point change and the settling of the output. The LAS:LDI command does not have any fixed delay for settling. With this command, some trigger pulses may be missed if the program step time is less than the 20 msec minimum.

A one shot trigger pulse will occur on power up of the instrument due to the states of the processor I/O.

TRIGGER OUTPUT BNC

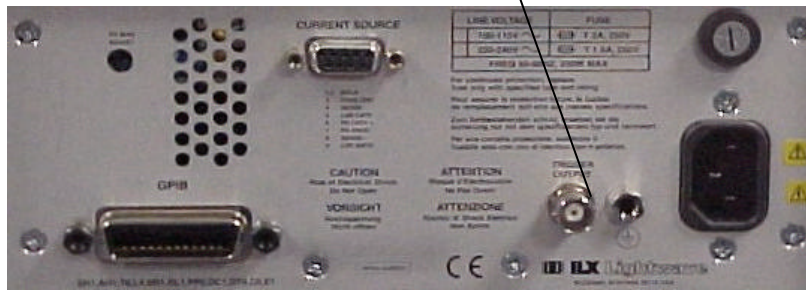

FIGURE 5.1 LDX-3200 Series Rear Panel

MODULATING THE LASER CURRENT SOURCE

The LDX-3200 Series Current Source allows a modulated signal to be superimposed on the source output current. For example, assume you are using an LED for your experiment where you need to operate the LED in constant current at $P_{OP} = 1 \text{ mW}$, with a modulated signal from 3 to 30 kHz. The experiment requires the LDX-3220's laser Current Source to be configured for the 200 mA range, high bandwidth mode with a limit of 175 mA. The allowable bandwidth of the modulated analog signal, defined as the 3 dB roll off point, is dependent on the LDX-3200 Series family member, the output current range, and the mode (constant current low/high bandwidth). See the section, LASER CURRENT SOURCE SPECIFICATIONS, in Chapter 1 for external analog modulation bandwidth specifications.



Setting up the Current Source for a modulated laser injection current is easy. The (MOD) **EXTERNAL** connector (BNC), on the front panel, is the input for the modulated signal. Connect a modulating voltage signal from a standard function generator, for example, to this connector. The modulation port input impedance is 10 k Ω . The transfer function (mA/V) shown is for the LDX-3220. This transfer function varies by model and laser drive current output range. The transfer function for the low and high current ranges of the LDX-3210 are 5 mA/V and 10 mA/V.



Set the LDX-3200 in Constant Current High Bandwidth Mode by selecting **I_{HBW}** in the **MODE** section of the front panel. Do this by toggling the (MODE) **SELECT** push button until the **I_{HBW}** indicator is illuminated. Repeatedly pressing the (MODE) **SELECT** switch cycles through the current (**I**), light power (**P**), or high bandwidth current (**I_{HBW}**) control modes.



Next, set the current source range by selecting the 200 mA range indicated by the accompanying LED. You will need to press the select push button twice to change the range. It must be pressed twice quickly (within less than 1 second) to switch between modes, and the current source output must be off (MODE ON indicator unlit) in order to change ranges.

The limit clamp function for DC output current applies to the modulated current as well protecting your laser in any mode. To accomplish setting the current source limit, use the (PARAMETER) **SELECT** push button **LIM I**. Press the (PARAMETER) **SET** push button and rotate the adjust knob. Set the limit to 175 mA. Once the (PARAMETER) **SET** push button is released, the new parameter value is stored in non-volatile memory.

When the laser current limit is reached, the **CURRENT LIMIT** error indicator flashes. The current limit setting is independent of the voltage drop of the device connected to the laser output, and therefore, no dummy load is required for precise adjustment of the current limit. Furthermore, since the current limit circuitry is fully independent of the main current control, the current limit can be adjusted safely, even while the current source output is active.

Now you are ready to modulate the laser injection current. To enable the Current Source output, press the push button labeled (MODE) **OUTPUT**. The accompanying LED labeled **ON** will illuminate indicating that the laser current source's output is enabled. The instrument will drive the current source to the value set by the corresponding **MODE** set point. Turn on the function generator (modulation source) to inject the modulation signal.

To disable the output, press the **OUTPUT** push button again. When the LDX-3200 current output is off, an internal short is placed across the output. This short will prevent the modulation signal from reaching the LED in our example experiment. Thus, it is safe to disconnect the test device (LED) when the LDX-3200's output is off, regardless of the presence of the modulation signal.

CHAPTER 6	1
CALIBRATION AND TROUBLESHOOTING GUIDE	1
INTRODUCTION	1
Calibration Overview	1
Recommended Equipment	1
LOCAL CALIBRATION OF THE LDX-3200 SERIES CURRENT SOURCE	2
Current Source Calibration	3
I _{PD} Current Calibration	4
Laser Forward Voltage Measurement Calibration	5
REMOTE CALIBRATION OF THE LDX-3200 SERIES CURRENT SOURCE	6
Current Source Calibration	6
I _{PD} Current Calibration	8
Laser Forward Voltage Measurement Calibration	9
TROUBLESHOOTING GUIDE	10

Chapter 6

CALIBRATION AND TROUBLESHOOTING GUIDE

Introduction

This chapter describes calibration of your LDX-3200 Series Current Source. Descriptions of the required test instruments, calibration conditions, and the detailed procedures for calibration of the instrument's Laser Diode Current Source are included. A troubleshooting guide is also offered for some of the more common failure symptoms. This chapter is divided into three major sections, Local (front panel) calibration, remote (through the GPIB Interface) calibration, and a troubleshooting guide.

Calibration Overview

There are several calibrations to be performed for a completely calibrated LDX-3200 Current Source. The Laser Diode Current Source calibration consists of calibrating the current source in both ranges and both modes (low and high bandwidth), calibrating the PD monitor feedback ammeter and finally the forward voltage measurement. The current limits are calibrated internally by the instrument as part of the calibration process.

Your LDX-3200 Series Current Source can be calibrated with the case closed. It should be calibrated every 12 months or whenever performance verification indicates that calibration is necessary, such as differences between set point and measurement display values which exceed the accuracy specification. Calibrate the instrument under laboratory conditions. We recommend calibration at $23^{\circ}\text{C} \pm 1.0^{\circ}\text{C}$. When necessary, however, the LDX-3200 Series Current Source may be calibrated at its intended use temperature if this is within the specified operating temperature range of 0 to 40°C .

Finally, the LDX-3200 Series Current Source should be allowed to warm up for at least 1 hour before calibration.

Recommended Equipment

Recommended test equipment for calibrating the LDX-3200 Series Current Source is listed in Table 6.1. Equipment other than that shown in the table may be used if the specifications meet or exceed those listed.

<u>Description</u>	<u>Mfg./Model</u>	<u>Specification</u>
DMM	HP 3457A	DC Amps (@ 1.0 A): $\pm 0.02\%$ Resistance (@ $10\ \Omega$): $\pm 0.02\%$ 0.1 μA or 0.1 mV resolution

Table 6.1 Recommended Test Equipment

It will be necessary to connect various loads and circuits to the outputs of each Current Source for the calibration procedure. A schematic is shown in Figure 6.1 for the photodiode calibration circuit with the required components listed in Table 6.2. Also, the devices required for other calibration loads are listed in Table 6.2.

<u>LASER CURRENT SOURCE CALIBRATION</u>		
Current Source Calibration, all models		1Ω 20W resistor, low TCR
Voltage Measurement Calibration		
LDX-3210		100Ω 2W resistor, low TCR
LDX-3220		25Ω 5W resistor, low TCR
<u>PHOTO-DIODE MONITOR CALIBRATION (See schematic in Fig. 6.1)</u>		
PD cal circuit		
R1		49Ω resistor, 1% , ¼ W
R2		100Ω resistor, 1%, ¼ W
R4		1.0 MΩ resistor, 1%, ¼ W
R3		
LDX-3210		49Ω, ½ W, low TCR
LDX-3220		11Ω, 1 W, low TCR
U1		TIL 117 opto isolator

Table 6.2 Required Calibration Components

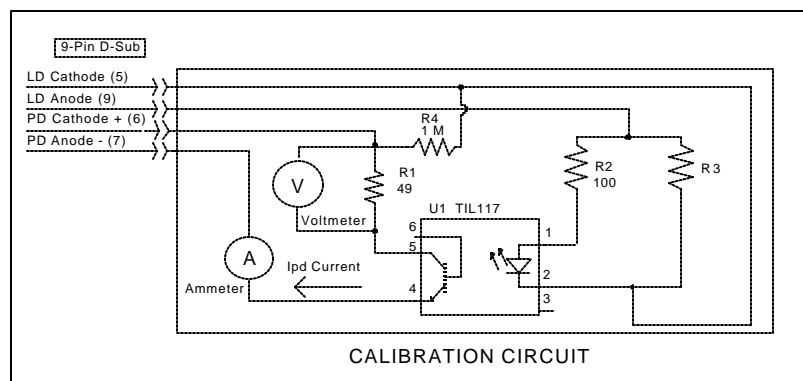

Figure 6.1 I_{PD} Calibration Circuit

LOCAL CALIBRATION OF THE LDX-3200 SERIES CURRENT SOURCE

There are three calibration adjustments required for the LASER current source of the LDX-3200 Series Current Source. They are calibration of the constant current source for both bandwidths and ranges, calibration of the laser voltage measurement, and calibration of the constant light power (I_{PD}) feedback circuits.

The LDX-3200 Series Current Source implements a two-point calibration for the Laser current source. Two currents (approximately 80% and 20% of FS) are applied to a test load, and the resulting actual currents are fed back (by the user) to the Current Source. The Laser Current Source calibration program uses the two sets of data to calculate new calibration constants. These calibration constants are used to set the actual current output of the current source.

Current Source Calibration

The following procedure is for calibrating each range of the current source. Calibration must be performed on both bandwidth modes. A total of four calibrations will be performed on the current source. Start with the low range, low bandwidth mode.

Configure the Laser Current Source in the following state:

FUNCTION	STATE
MODE	I (constant current low bandwidth)
RANGE	low (lowest per instrument model)
CURRENT LIMIT	90% of FS (full scale of range)
SET POINT	80% of FS

- Measure and record the resistance of a 1 Ω , 20 W resistor (a 4-point probe resistance measurement is recommended). Connect the load resistor across the LASER output terminals (Laser Anode and Laser Cathode) on the 9 pin connector of the rear panel.
- Connect the calibrated DMM across the load resistor. Configure the multimeter to measure voltage in volts. You will be calculating the actual Laser current in the following manner using Ohm's Law.

$$I = E / R$$

--where E is the accurately measured voltage across the resistor, and R is the accurately measured load resistance. I is the actual Laser current in Amps.

NOTE

Check the current measuring range of your multimeter. You may be able to measure Laser Output current in mA by connecting the meter directly to the outputs of the Laser Current Source.

- Press the (MODE) **ON** switch to turn the current source output on. The output must be on in order to enter the LASER I calibration mode.
- Enter the **LASER I** calibration mode by pushing the (GPIB) **LOCAL** and (DISPLAY) **SELECT** switches at the same time. The display will blank and the Current Source will drive the current output to the set point and the Display will indicate output current in mA.
- Calculate the actual current through the load as described in step b. Press and hold in the (PARAMETER) **SET** switch and turn the adjust knob until the display indicates the calculated actual current.
- Release the (PARAMETER) **SET** switch. After the (PARAMETER) **SET** switch is released, the Current Source will drive the current output to about 25% of the first calibration set point.
- Calculate the measured current again through the load resistor.

- h. Press and hold in the (PARAMETER) **SET** switch and turn the adjust knob until the display indicates the actual current as calculated in step g.
- i. Release the (PARAMETER) **SET** switch to accept the second calibration point. After the (PARAMETER) **SET** switch is released, the Current Source will calculate the calibration constants and store them to nonvolatile memory. In low bandwidth calibration mode, the LDX-3200 Series Current Source will also perform current limit calibration, indicated by the **CURRENT LIMIT** LED flashing.
- j. Turn the current source output off. Change the Mode to I_{HBW} (high bandwidth constant current mode). Repeat the calibration procedure as described above.
- k. Change the output range to High range and repeat the calibration procedure as described above.

I_{PD} Current Calibration

The following procedure is for calibrating the LASER I_{PD} (photodiode monitor) set point and measurement. This procedure calibrates the feedback circuits for constant I_{PD} and constant P_{PD} modes. When these values are reached and are stable, the user enters the actual value of the monitor current, measured with a DMM. The LDX-3200 Series Current Source then automatically calibrates the LASER feedback circuits.

Configure the Current Source in the following manner for the Laser Current Source calibration:

FUNCTION	STATE
MODE	P (constant power)
CAL PD	set equal to zero
CURRENT LIMIT	90% of FS (full scale of range)
I_{PD} Set POINT	80% of FS

- a. With the LASER output off, connect a calibrated ammeter to the PD Anode output of the Laser Current Source output connector (9 pin on rear panel), and connect the circuit of Figure 6.1 to the LASER and PD outputs with the correct load resistor for the Current Source model you are calibrating (See Table 6.2).

NOTE

If a precision ammeter is not available, use a zero-Ohm jumper in place of the ammeter. Then, place a calibrated DMM (with 0.1 mV resolution) to measure the voltage across the resistor, R_I , as shown in Figure 6.1. Calculate the current in the following steps by using Ohm's Law:

$$I = E / R$$

--where E is the accurately measured voltage across the resistor, and R is the accurately measured load resistance. I is the actual pd current to be measured by the LDX-3200 Current Source. (A 4-point probe resistance measurement is recommended.)

- b. Press the (MODE) **ON** switch to turn the current source output on. Verify proper operation, i.e. the I_{PD} measurement (via DMM) and set point should be close, and the unit should not be in current limit.
- c. Press the (GPIB) **LOCAL** and **FINE** switches at the same time to place the Current Source in its I_{PD} Current Calibration mode.

After a few seconds the display will show the I_{PD} set point value.

- d. After the value on the display is stable (has not changed by more than one digit for several seconds) the LDX-3200 Series Current Source is ready for the actual I_{PD} value to be entered.

Press and hold in the (PARAMETER) **SET** switch and turn the adjust knob until the display shows the actual monitor current, as shown on the calibrated ammeter (or the calculated I_{PD} value from Step a).

- e. Release the (PARAMETER) **SET** switch to store the first calibration value. The Current Source will then set the second calibration current, approximately one-fourth (1/4) of the original current. (For example, if the first calibration set point was 4000 μ A, the second set point will be about 1000 μ A.)
- f. Press and hold in the (PARAMETER) **SET** switch and turn the adjust knob until the display indicates the actual current as measured by the ammeter or as calculated.
- g. Release the (PARAMETER) **SET** switch to accept the second calibration point. After the (PARAMETER) **SET** switch is released, the LDX-3200 Series Current Source will calculate the calibration constants and store them to nonvolatile memory.

Laser Forward Voltage Measurement Calibration

The following procedure is for calibrating the LASER voltage measurement.

Configure the Current Source in the following manner for the Laser Current Source Voltage calibration:

FUNCTION	STATE
LASER MODE	I (constant current low bandwidth)
RANGE	
LDX-3210	100 mA
LDX-3220	500 mA
CURRENT LIMIT	set to FS (full scale of range)
I SET POINT	
LDX-3210	60 mA
LDX-3220	400 mA

- a. With the current source output off, connect a calibrated voltmeter, in parallel with a resistor (100 Ω , 2 Watt for the LDX-3210; 15 Ω , 5 Watt for the LDX-3220), to the LASER output (Laser Anode and Laser Cathode) on the rear panel of the Current Source.
- b. Press the (MODE) **ON** switch to turn the current source output on. The current source output must be on in order to enter the LDV calibration mode.

- c. Enter the **LASER V** calibration mode by pushing the (GPIB) **LOCAL** and **RANGE** switches at the same time. The display will blank and the Current Source will drive the LASER current output to the respective set point and the display will indicate forward voltage in Volts.
- d. Enter the measured voltage (in volts). Press and hold in the (PARAMETER) **SET** switch and turn the adjust knob until the display indicates the measured voltage.
- e. Once the actual voltage value is entered, the Current Source will set the current to approximately one-fourth (1/4) of the original value. It will then expect the second calibration voltage point.
- f. Input the second actual (measured) LASER forward voltage as in Step d.
- g. Once the second actual voltage value is entered, the Current Source will store the new calibration constants.

This ends the section on front panel calibration of your LDX-3200 Series Current Source. The next section discusses calibration through the IEEE488.2 GPIB interface.

REMOTE CALIBRATION OF THE LDX-3200 SERIES CURRENT SOURCE

The LDX-3200 Series Current Sources can be calibrated remotely via the GPIB Interface. All of the required calibration commands are listed in Table 4.1 in Chapter 4. The procedures below are general guidelines for writing a program to calibrate your instrument.

NOTE

*The operation complete flag (bit 0 of the Standard Event Status Register) may be used to trigger a service request. This type of interrupt is enabled by setting bit 0 of the Service Request Enable register (via the *ESE command) and bit 5 of the Service Request Enable register (via the *SRE command). Service request (SRQ) handling depends on your GPIB hardware. Refer to your GPIB user's manual for details.*

*After a calibration value is entered, the "*OPC?" query may be used to determine when the calibration sequence is done. However, the "*OPC", or "*WAI" command, or "*OPC?" query should not be issued until after the expected calibration value is entered, or the system will "hang". This happens because the LDX-3200 Series Current Source will wait indefinitely for an input, yet not allow any input until the calibration is finished.*

Current Source Calibration

There are three calibration adjustments required for the LDX-3200 Series Current Source. They are calibration of the constant current source for both bandwidths and ranges, calibration of the laser voltage measurement, and calibration of the constant light power (I_{PD}) feedback circuits.

The LDX-3200 Series Current Source implements a two-point calibration for the current source. Two currents (approximately 20% and 80% of FS) are applied to a test load, and the resulting actual currents are fed back (by the user) to the Current Source. The Laser Current Source calibration program uses the two sets of data to calculate new calibration constants. These calibration constants are used to set the actual current of the current source.

The following procedure is for calibrating each range of the current source. Start with the low range. After calibration is complete in this range, switch to the high range and repeat the procedure.

Configure the Current Source in the following manner for the Laser Current Source calibration:

FUNCTION	STATE	GPIB COMMAND
LASER MODE	I (constant current low bandwidth)	LAS:MODE:ILBW
RANGE	low (lowest per instrument model)	LAS:RAN x
LIMIT	90% of FS (full scale of range)	LAS:LIM:Ix
SET POINT	80% of FS	LAS:LDI

- a. Measure and record the resistance of a 1 Ω, 20 W resistor (a 4-point probe resistance measurement is recommended.). Connect the load resistor across the LASER output terminals (Laser Anode and Laser Cathode) on the 9 pin connector of the rear panel.
- b. Connect the calibrated DMM across the load resistor. Configure the multimeter to measure voltage in volts. You will be calculating the actual Laser current in the following manner using Ohm's Law.

$$I = E / R$$

--where E is the accurately measured voltage across the resistor, and R is the accurately measured load resistance. I is the actual Laser current in Amps.

- c. The current source output must be on in order to enter the LASER I calibration mode. Enter the "LAS:OUTPUT ON" command to turn the current source output on.
- d. Enter the LASER I calibration mode by issuing the "LAS:CAL:LDI" command. The display will indicate a current in mA.
- e. Input the first actual (measured) output current (as an <nrf value>) via the "LAS:LDI <nrf value>" command.

If this value is to be measured and entered remotely via a GPIB controlled DMM, for example, the measured value of the current should not be entered until the LDX-3200 Series Current Source is ready to receive it: The Current Source will be ready to receive the new measured value when, after a "LAS:CAL:LDI?" query is sent, the response from the Current Source is "1".

- f. Once the newly measured I value is entered via the "LAS:LDI" command, the Current Source will apply a new current equal to about 25% of the previous set current.

- g. Input the second actual (measured) output current (as an <nrf value>) as in Step e.
- h. Once the second actual I value is entered via the "LAS:LDI" command, the new calibration constants will be calculated and stored into non-volatile memory. In low bandwidth calibration mode, the LDX-3200 Series Current Source will also perform current limit calibration as indicated by the **CURRENT LIMIT** LED flashing. The "OPC?" query may be used (after the "LAS:LDI" value is sent) to determine when the calibration is completed. Or, wait about 2 seconds before continuing with other GPIB commands.
- i. Turn the current source output off. Change the Mode to I_{HBW} (high bandwidth constant current mode) with the LAS:IHBW command. Repeat the calibration procedure as described above.

I_{PD} Current Calibration

The following procedure is for calibrating the LASER I_{PD} constant current source. This procedure calibrates the feedback circuits for constant I_{PD} and constant P_{PD} modes. When these values are reached and are stable, the user enters the actual value of the current, as measured by an external DMM. The LDX-3200 Series Current Source then automatically calibrates the LASER feedback circuits.

Configure the Current Source in the following manner for the Laser Current Source calibration:

FUNCTION	STATE	GPIB COMMAND
LASER MODE	P (constant power)	LAS:MODE:MDP
CAL PD	set equal to zero	LAS:CALMD
CURRENT LIMIT	90% of FS (full scale of range)	LAS:LIM:IX
I_{PD} Set POINT	80% of FS	LAS:MDI

- a. With the LASER output off, connect a calibrated ammeter to the PD Anode output of the Laser Current Source output connector (9 pin on rear panel), and connect the circuit of Figure 6.1 to the LASER and PD outputs with the correct load resistor for the Current Source model you are calibrating (See Table 6.2).
- b. Enter the "LAS:OUT ON" command to turn the LASER output on. Verify proper operation, i.e. the I_{PD} output should be close to the set point, and the unit should not be in current limit (read the limit status via the "LAS:COND?" query, bit 0).
- c. Enter the "LAS:CAL:MDI" command to place the Current Source in its LASER Current Calibration mode. The Current Source will increase the laser current output until the current at the PD monitor (I_{PD}) inputs equals the targeted set point.
- d. After a few seconds, the Current Source will be ready for the actual I_{PD} current to be entered via the "LAS:MDI <nrf value>" command. The measured value of the current should not be entered until the Current Source is ready to receive it. The Current Source will be ready to receive the current value when, after a "LAS:CAL:MDI?" query is sent, the response from the Current Source is "1".
- e. Once the actual I_{PD} value is entered via the "LAS:MDI <nrf value>" command, the Current Source will store the new calibration value. It will then set the output to approximately one-fourth (1/4) of the original current. (For example, if the first calibration set point was 4000 μ A, the second set point will be 1000 μ A.) Then, it will be ready to receive the second calibration value.

- f. Input the second actual (measured) monitor diode current (as an <nrf value>) as in Step d.
- g. Once the second actual I_{PD} value is entered via the "LAS:MDI" command, the new calibration constants will be calculated and stored into non-volatile memory. The "OPC?" query may be used (after the "LAS:MDI" value is sent) to determine when the calibration is completed. Or, wait about 2 seconds before continuing with other GPIB commands.

Laser Forward Voltage Measurement Calibration

The following procedure is for calibrating the LASER voltage measurement.

Configure the Current Source in the following manner for the Laser Current Source Voltage calibration:

FUNCTION	STATE	GPIB COMMAND
LASER MODE RANGE	I (constant current low bandwidth)	LAS:MODE:ILBW
LDX-3210	100 mA	LAS:RANGE 1
LDX-3220	500 mA	LAS:RANGE 5
CURRENT LIMIT I Set POINT	set to FS (full scale of range)	LAS:LIM:ix
LDX-3210	60 mA	LAS:LDI 60
LDX-3220	400 mA	LAS:LDI 400

- a. With the LASER output off, connect a calibrated voltmeter, in parallel with a resistor (100 Ω , 2 Watt resistor for the LDX-3210; 15 Ω , 5 Watt resistor for the LDX-3220), to the LASER output (Laser Anode and Laser Cathode) on the rear panel of the Current Source.
- b. The current source output must be on in order to enter the LDV calibration mode. Enter the "LAS:OUT ON" command to turn the current source output on.
- c. Enter the "LAS:CAL:LDV" command to place the Current Source in its LASER Voltage Calibration mode.
- d. Enter the measured voltage (in volts) via the "LAS:LDV <nrf value>" command. The measured value of the voltage should not be entered until the LDX-3200 Series Current Source is ready to receive it. The current source will be ready to receive the voltage value when, after a "LAS:CAL:LDV?" query is sent, the response from the Current Source is "1".
- e. Once the actual voltage value is entered via the "LAS:LDV <nrf value>" command, the Current Source will set the current to approximately one-fourth (1/4) of the original value. It will then expect the second calibration voltage point.
- f. Input the second actual (measured) LASER forward voltage (as an <nrf value>) as in Step d.
- g. Once the second actual voltage value is entered via the "LAS:LDV" command, the Current Source will store the new calibration constants. The "OPC?" query may be used (after the "LAS:LDV" value is sent) to determine when the calibration is completed. Or, wait about 2 seconds before continuing with other GPIB commands.

TROUBLESHOOTING GUIDE

This section is a guide to troubleshooting the LDX-3200 Series Current Sources. Some of the more common symptoms are listed here, and the appropriate troubleshooting actions are given. We recommend that the user start at the beginning of this guide. Read the symptom descriptions, and follow the steps for the corrective actions which apply. If you encounter problems which are beyond the scope of this guide, contact your ILX Lightwave customer service representative.

<u>SYMPTOM</u>	<u>CORRECTIVE ACTIONS</u>
GENERAL	
LDX-3200 Series unit will not power up	Check AC Power line voltage and power cord connection.
Power on, but display is frozen, switches don't Operate	This may occur if the instrument loses power (AC line) briefly. Turn the power switch off and on again to restart.
Displays E514 on power up on display	Hold (GPIB) LOCAL button, RANGE button, and FINE button as you are powering up the instrument. This clears the Laser board EEPROM, LLLLL will be displayed on the display. Need to recalibrate the Laser Current Source.
Instrument resets at power up or any LASER mode change	Hold (GPIB) LOCAL button, RANGE button, and FINE button as you are powering up the instrument. This clears the Laser board EEPROM, LLLLL will be displayed on the display. Need to recalibrate the Laser Current Source.
LASER CURRENT SOURCE	
Power on, but no current output	Check Interlock pins on LASER input connector on instrument rear panel. These pins must be shorted either directly or through a switch. If OPEN CIRCUIT indicator is lit check the load connections and then try again. Check the OUTPUT ON switch, the corresponding LED should be lit.

SYMPTOM

CORRECTIVE ACTIONS

Output current at limit, can't be lowered	<p>If POWER mode is used, check the monitor diode (feedback) connections. Try reversing the polarity of the monitor photodiode. Check also the photodiode bias adjustment on the rear panel.</p> <p>If in I or I_{HBW} mode, check the current set point and I LIMIT setting. Setting the output below the limit may require several turns of the adjust knob if the set point is much greater than the desired limit setting.</p>
Output goes off intermittently	<p>Check the interlock circuit. An intermittent interlock will turn the output off.</p> <p>Check that the AC power cord connection is secure. Power-line drop-outs may reset the unit and when power is restored, the output will be off.</p>
Unable to adjust output	Check the I LIMIT parameter for the output range in use, see that it is set above 0 mA.
Power Mode operation has high output current, but little or no power is measured	Check back panel PD BIAS. If set too low, may act as an open feedback loop. If in doubt, set the PD BIAS to mid range (2.5 V).
Output exceeds Power Limit	The "Power Limit" is not a hardware limit. It only serves as a warning that the power measurement has exceeded the limit set point. Normally this limit will cause the output to shut off. This feature can be defeated via the "LAS:ENABLE:OUTOFF" command.
Open Circuit Error occurs during calibration	Check load connections. Check that measuring meter does not auto-range (use non-auto-ranging modes).
Calibration is aborted unintentionally	Calibration modes will be aborted if an open circuit is detected.
VOLTAGE LIMIT indicator blinks	This indicates a voltage limit error. Check laser connections. A high impedance may cause this condition.
Open circuit error E503 or Voltage Limit error E505 prevents output from reaching desired value.	The LDX-3200 Series instruments have an adjustable laser compliance voltage. Check to see if the LASER voltage limit setting is too low (see Chapter 2). Check laser connections.